

Mycore Collections Catalogue

Mycore Collections Catalogue

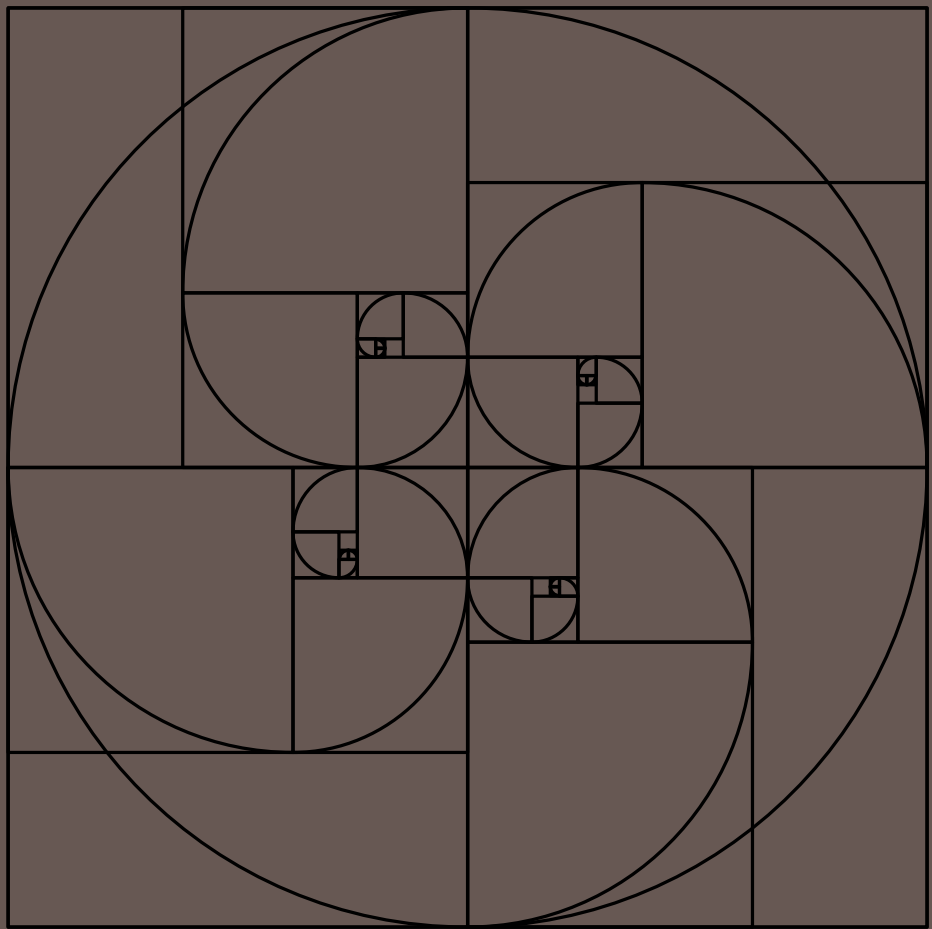

Contents

06 **Company profile**

26 **Collections**

26 **Phantom**

30 **Simply**

34 **Ekstro**

38 **Trej**

42 **Groove**

46 **Flexy**

50 **Quaver**

54 **Border**

61 **Technical info**





“

**Architecture is the masterly,
correct, and magnificent play
of masses brought together in light.**

*L'Architettura è il gioco sapiente,
rigoroso e magnifico dei volumi
sotto la luce.*

Le Corbusier

Company profile

Let the light in

Accogliere la luce

The shadows begin to fade.
You wake up bathed in soft, diffused
light that gently embraces the room,
brings objects back to life, creates
endless new shapes for you to discover
and follows the flow of the day, creating
scenes that are constantly changing,
but always welcoming.

*Le ombre si schiariscono.
Il risveglio ti avvolge con una luce
morbida e distesa che accarezza
la stanza, riporta in vita gli oggetti,
ti accompagna a scoprire forme
sempre nuove e affianca il fluire
della giornata, modellando intorno
a te scenari mutevoli e accoglienti.*

**At every hour, the light
traces your living space.
With Mycore blinds,
it sculpts the space into
the shape of your desires.**

*A ogni ora, la luce tratteggia il tuo spazio
abitativo. Con le tende Mycore lo scolpisce
sulla forma dei tuoi desideri.*



The perfect living space

Lo scenario del perfetto abitare

With Mycore, roller blinds combine technical functionality with beauty.

Our collection of supports and fabrics dresses refined residential interiors and commercial spaces with a minimalist flavour, filtering or blocking light, improving a space's energy efficiency, ensuring privacy, or, when desired, allowing complete continuity between indoor and outdoor spaces.



Con Mycore le tende a rullo coniugano funzionalità tecniche e valore estetico.

La collezione di supporti e teli veste con gusto minimale interni residenziali e spazi contract raffinati, filtra la luce o la oscura, incrementa le performance energetiche degli ambienti, assicura la privacy o, a scelta, consente la totale continuità tra spazi interni ed esterni.

Giving shape to perfection

Dare forma alla perfezione

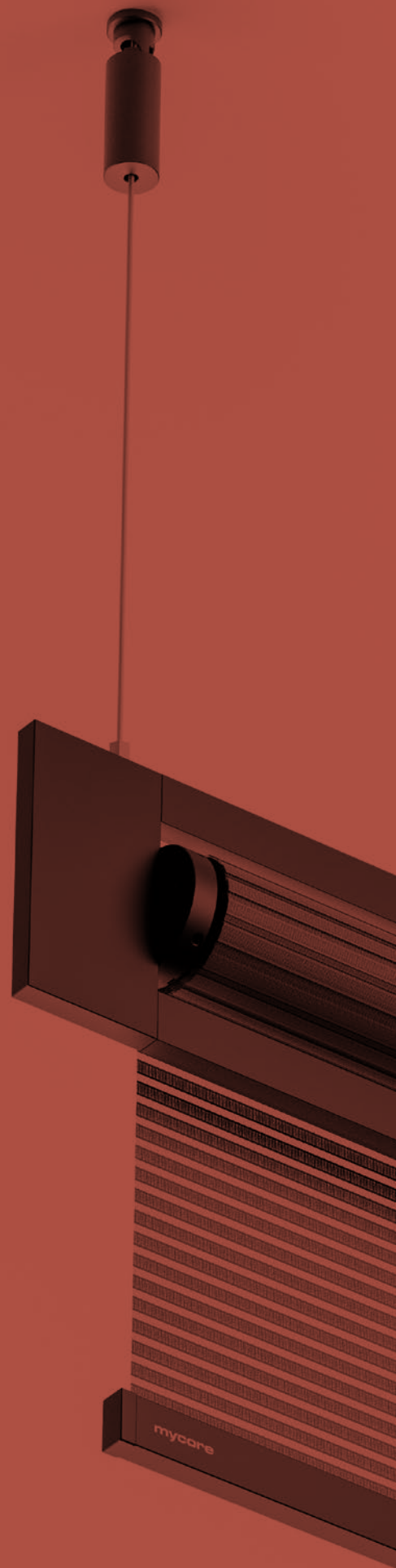

Mycore expresses the most authentic voice of Made in Italy, built on creativity and technological research, stylistic care and minute attention to detail. For over 15 years, we have designed and produced roller blinds entirely in Italy, becoming a point of reference on the market for technical perfection, iconic, essential design, and the ability to define different spaces and styles.

Attentive to changes in contemporary architecture, open to dialogue with designers, and sensitive to the evolution of standards of living, Mycore offers a wide range of solutions that furnish high-profile spaces all over the world, every day.

Mycore dà voce al più autentico Made in Italy, fondato su creatività e ricerca tecnologica, attenzione stilistica e cura scrupolosa dei dettagli. Da oltre 15 anni progetta e produce totalmente in Italia tende a rullo che rappresentano un punto di riferimento sul mercato per la perfezione tecnica, il design iconico ed essenziale, la capacità di definire ambienti e stili differenti.

Attenta ai mutamenti dell'architettura contemporanea, aperta al dialogo con progettisti e designer, sensibile alle evoluzioni dei canoni dell'abitare, Mycore offre un'ampia gamma di soluzioni che ogni giorno vestono spazi di prestigio in tutto il mondo.

Quality details

I dettagli della qualità

Mycore supports are made from milled aluminium, machined from solid. The concealed models are laser cut. Every single component is created with precision mechanics, perfected over years of technical planning. The fabrics are developed to offer high performance in terms of light adjustment, privacy, energy efficiency and acoustics.

Alongside these features, every creation stands out for the meticulous attention to even the most invisible details: a unique level of care that guarantees excellence in every product.

Mycore offers timeless products that can perfectly adapt to the space they are in.



I supporti Mycore sono realizzati in alluminio ricavato dal pieno. I modelli ad incasso sono realizzati con taglio a laser. Ogni singolo componente è caratterizzato da una meccanica di precisione, perfezionata in anni di progettazione tecnica. I teli sono studiati per offrire performance elevate in termini di gestione della luce, privacy, efficienza energetica e acustica.

Accanto a questi accorgimenti, ogni realizzazione è contraddistinta da una rigorosa cura dei dettagli più invisibili: un'attenzione unica che garantisce l'eccellenza di ogni prodotto.

Mycore offre prodotti senza tempo, in grado di adattarsi perfettamente all'ambiente che li ospita.



Efficiency and a long life: a responsible choice

Mycore offers long-lasting, superior quality products that will be by your side for years, reducing the resources needed for their maintenance, cleaning and disposal to a minimum. Additionally, the fabrics do not need to be washed in the washing machine, and help to increase the energy efficiency of buildings thanks to their superior ability to screen the sun's thermal energy.

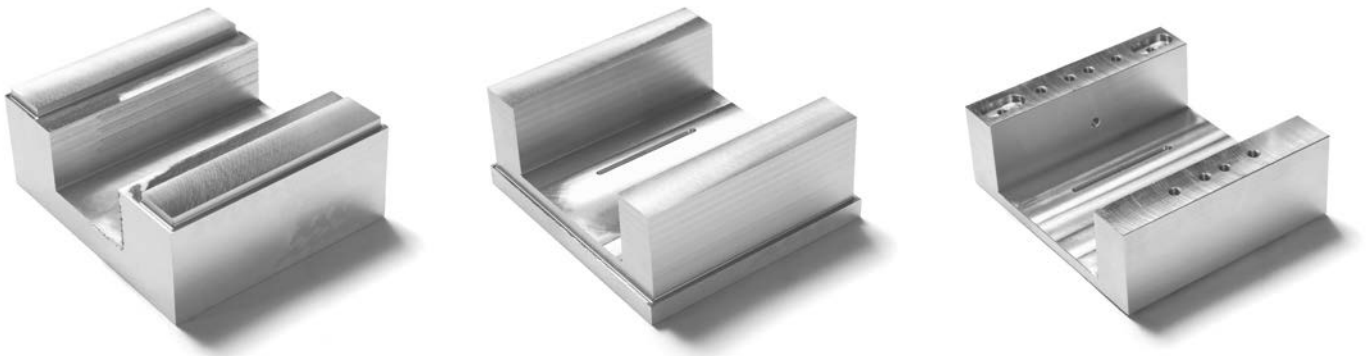

*Efficienza e durata: una scelta di responsabilità
Mycore offre prodotti durevoli e di qualità superiore, che ti accompagneranno nel tempo, riducendo al minimo il consumo di risorse per la manutenzione, la pulizia e lo smaltimento. I teli non devono inoltre essere lavati in lavatrice e contribuiscono ad incrementare l'efficienza energetica degli edifici attraverso una migliore schermatura dell'energia termica solare.*

Style and technology meld together in a harmonious collection that is superior in engineering and essential in design.

Single or multiple systems, ceiling-mounted, suspended or wall-mounted; concealed systems or more pronounced, visible supports: Mycore offers solutions and options designed to cater to the most diverse range of architectural and aesthetic requirements.

Along with traditional blind functionality, Mycore products also act as a piece of furniture that at different moments can become a light source, a room divider, a projector screen or a decorative set piece.

Minimalist, versatile design

Design minimale e versatile

Stile e tecnica si fondono in una collezione armonica, superiore sul fronte progettuale, essenziale nel design.

Sistemi singoli o multipli, a soffitto, in sospensione o a parete; sistemi a scomparsa o supporti dal carattere più forte e marcato: Mycore propone soluzioni e varianti pensate per interpretare le più diverse esigenze architettoniche ed estetiche.

Alla funzionalità della tenda tradizionale si affianca inoltre la capacità di costituire un complemento d'arredo che di volta in volta diventa punto luce, divisorio d'ambiente, schermo di proiezione o elemento scenografico decorativo.

**The evanescent
brightness of white, the
sharp strength of aluminium,
the contemporary flavour
of Dupont™ Corian®, or the
strong character of black:
Mycore's materials offer
many finishes to express
different tastes.**

*La leggerezza evanescente del bianco,
la tempra graffiante dell'alluminio, il sapore
contemporaneo del Dupont™ Corian®
o il carattere deciso del nero antracite:
i materiali Mycore prevedono molteplici
finiture per dare voce a gusti differenti.*



**Infinite possibilities:
to interpret every
desire, every technical
requirement, every
opportunity offered
by a space.**

*Possibilità infinite: per interpretare
ogni desiderio, ogni necessità tecnica,
ogni opportunità offerta dall'ambiente.*

Smooth, silent movements

Mycore systems are available in motorised, battery-powered or chain operated versions. Our careful research on types of mechanism and use of high quality materials allows us to obtain seamless, perfectly calibrated blind movements, silent automation and end of roll adjustments with absolute precision.

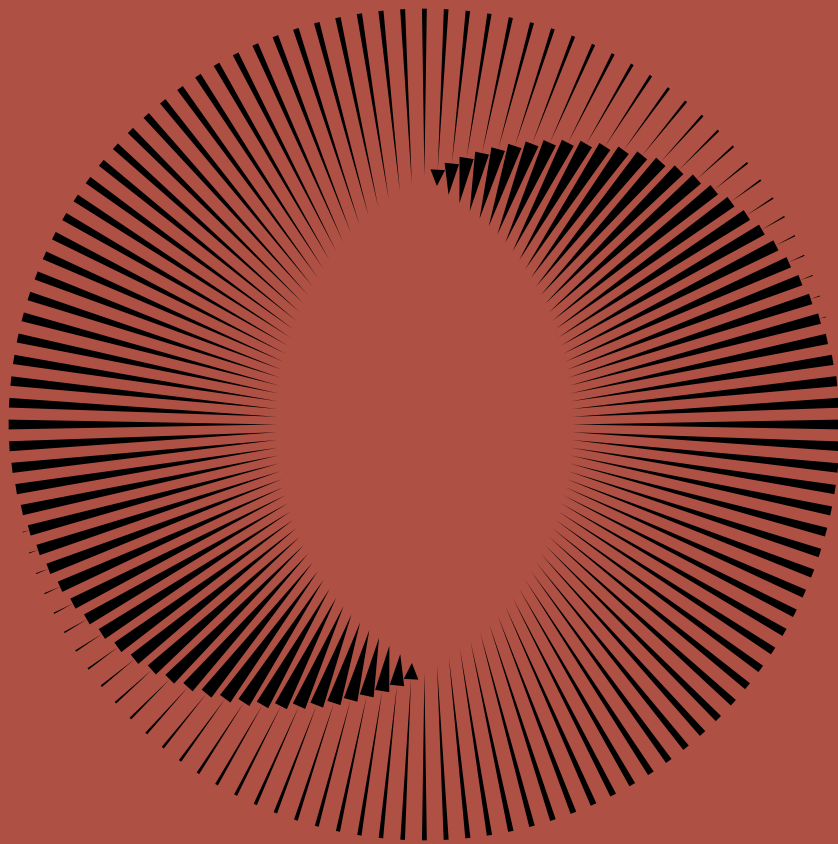

Movimentazioni fluide e silenziose

I sistemi Mycore sono disponibili nelle versioni a motore, a batteria o a catena. L'attento studio delle tipologie di meccanismo e l'utilizzo di materiali di elevata qualità permette di ottenere movimentazioni dei teli fluide e perfettamente calibrate, automazioni silenziose e regolazioni a fine corsa di assoluta precisione.

A vast choice of fabrics

Una vasta scelta tessile

Weaves developed to regulate light and heat, contributing to the energy efficiency of a building. Darkening or filtering fabrics to best adjust indoor light. Sound-absorbing, fireproof or reflective blinds to guarantee superior performance. Printable, magnetic or video-projection blinds to cater to specific requirements. Mycore offers an extraordinarily wide range of fabrics, with a broad variety of styles and textures, to express different approaches to design and architecture.

Thanks to how easy and quick it is to replace, the fabric can also be changed over time according to new trends or new uses for the space.

Trame studiate per regolare luce e calore, contribuendo alla resa energetica degli edifici. Tessuti oscuranti o filtranti per gestire al meglio l'illuminazione di un interno. Tende fonoassorbenti, ignifughe o riflettenti per assicurare performance superiori. Teli stampabili, magnetici o da videoproiezione per rispondere a particolari esigenze. Mycore offre una gamma tessile di straordinaria ampiezza, con un'elevata varietà di stili e texture, per interpretare differenti approcci al design e all'architettura.

Grazie alla semplice e rapida sostituzione, il telo potrà inoltre cambiare nel tempo in base a nuove tendenze o rinnovate destinazioni d'uso dell'ambiente.

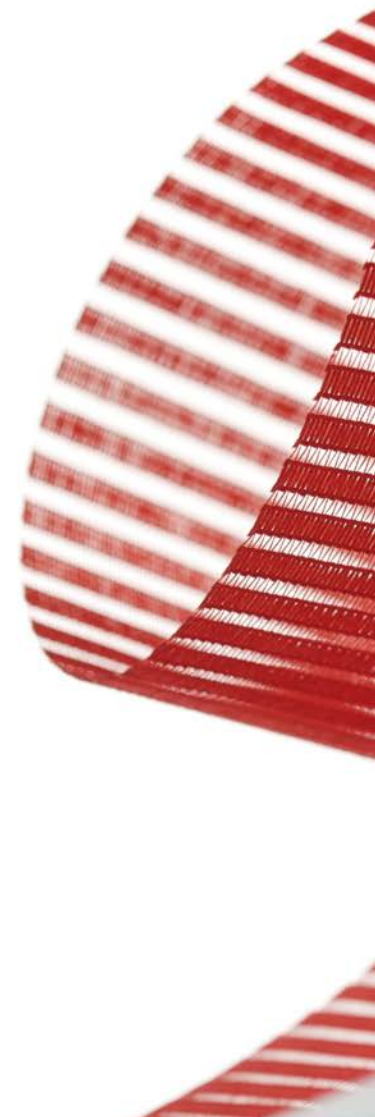



Fully personalised fabrics

As well as our extensive collection of fabrics, Mycore offers the possibility of printing fully personalised fabrics in terms of colour schemes and aesthetics, using images agreed on with the client or creating exclusive designs.

*Personalizzazione completa dei tessuti
Accanto all'ampia collezione tessile,
Mycore offre la possibilità di stampare
tessuti totalmente personalizzati in
termini di cromia ed estetica, utilizzando
immagini concordate con il cliente o
progettando design esclusivi.*



Set the scene with a simple command

Definire lo scenario, in un semplice comando

Mycore offers solutions and products that can be integrated with smart spaces or home automation, so you can manage your roller blinds through iOS and Android apps and the most popular voice assistants for home management.

You can define your settings to position the blinds at the desired height, programme them on a daily or weekly basis, plan automatic controls based on the information provided by optional sensors in the house, and modify them over time depending on your needs.

An integrated home automation system that allows you to enjoy the perfect living environment at any time.

Un sistema di home automation integrato per lasciarsi accogliere, in ogni momento, dallo scenario del perfetto abitare.

Mycore propone soluzioni e prodotti che si integrano negli ambienti domotici o con funzionalità di home automation, per gestire le tende a rullo mediante app da dispositivi mobili iOS e Android, anche attraverso i più comuni assistenti vocali per il controllo della casa.

Potrai definire i tuoi scenari per posizionare i teli all'altezza desiderata, programmarli su base giornaliera e settimanale, prevederne l'autoregolazione in funzione dei dati forniti da eventuali sensori presenti in-house e modificarli nel tempo sulla base delle tue esigenze.

Mycore collaborates with architects and interior designers every day. We work with them in the preliminary planning phases to identify the most suitable products for the technical and aesthetic characteristics of a space, or develop custom solutions designed around them.

Working with architects and designers

Accanto ad architetti e designer

Mycore dialoga ogni giorno con architetti e interior designer. Li affianca nelle fasi preliminari di progettazione per individuare i prodotti più adatti alle specificità tecniche ed estetiche dell'ambiente o sviluppa su loro impulso soluzioni custom.

Solutions for every architectural requirement

Mycore roller blind systems are able to meet even the most demanding architectural challenges, such as curved walls, sloped ceilings, corners or niches. When these challenges exceed all expectations, the R&D department can develop ad hoc solutions thanks to a team of designers with two decades of experience and an in-house workshop, giving us the ability to provide new, unique responses to requirements on a case by case basis.

Soluzioni per ogni esigenza architettonica

I sistemi di tende a rullo Mycore sono in grado di superare le sfide architettoniche più impegnative come pareti curve, soffitti inclinati, angoli o nicchie. Quando queste si spingono oltre ogni previsione, il reparto R&D sviluppa soluzioni ad hoc grazie a un team di progettisti dall'esperienza ventennale e al laboratorio interno, in grado di fornire risposte mirate a esigenze di volta in volta uniche e nuove.



“

**More and more, so it seems to me,
light is the beautifier of the building.**

*Sempre di più, a mio parere,
la luce impreziosisce gli edifici.*

Frank Lloyd Wright

Phantom

Installation

Hidden into plaster ceiling
A scomparsa nel controsoffitto

Type

Single or combined version
Singolo o abbinato

Product variants

Corner combination, reduced
 false ceiling, side rails (custom)
*Combinazione ad angolo,
 controsoffitti di piccole dimensioni,
 guide laterali (su misura)*

Operation

Motorized system
A motore

Lowering of the fabric

In front or behind the roller
*Discesa del telo: davanti
 o dietro all'avvolgibile*

Fabrics

Fabrics with different covering
 properties, sound-absorbing
 fabrics, printed fabrics and
 for video projection
*Tessuti con diversi gradi di copertura,
 tessuti fonoassorbenti, tessuti
 stampati e per proiezioni video*

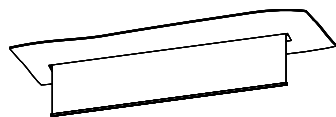

Technical info

→ P. 62





—
Picture:
Phantom / Double Vertical

—
Finishes:
Pure White 9010

—
Fabrics:
5101/10 — 5148/09

Phantom



Finishes

Finiture



Pure White 9010

The epitome of Mycore's essential nature. With a completely invisible support built into a false ceiling, Phantom is the ideal choice to furnish spaces with a highly contemporary, minimalist character.

Un distillato dell'essenzialità di Mycore. Con il supporto totalmente invisibile e integrato nel controsoffitto, Phantom si presta a vestire spazi dal forte carattere contemporaneo e minimale.

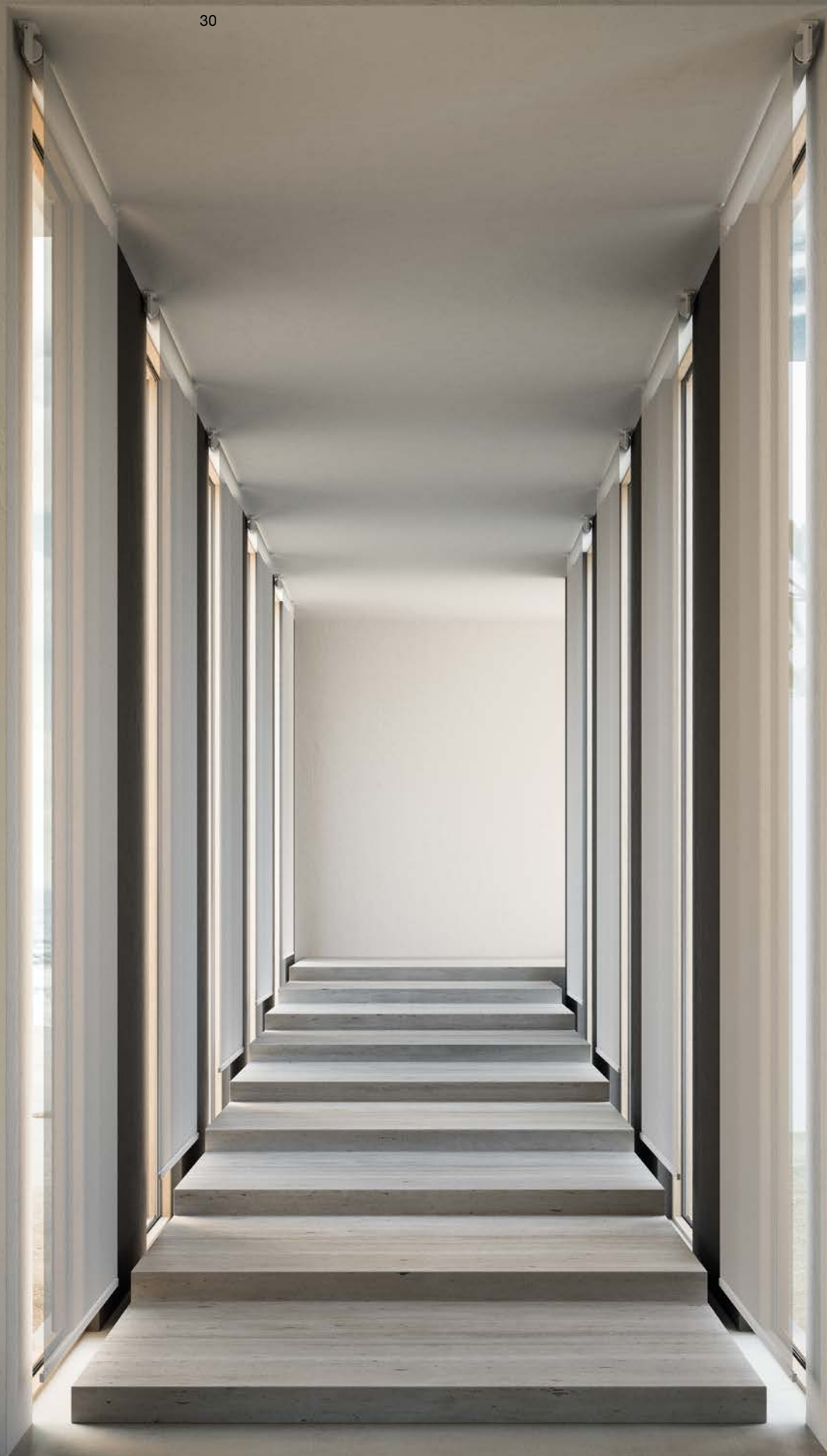

Simply

Installation

Ceiling or wall mounted
A soffitto o a parete

Type

Single or combined version
Singolo o abbinato

Product variants

Double rollers with two variations
 in the overhang, angular supports
*Doppio con due livelli di sporgenza,
 supporto angolare*

Operation

Moved by chain,
 or motorised system
A catena, a motore

Lowering of the fabric

Standard in front of the roller
*Discesa del telo: standard
 davanti all'avvolgibile*

Fabrics

Fabrics with different covering
 properties, sound-absorbing
 fabrics, printed fabrics and
 for video projection
*Tessuti con diversi gradi di copertura,
 tessuti fonoassorbenti, tessuti
 stampati e per proiezioni video*

Technical info

→| P. 68

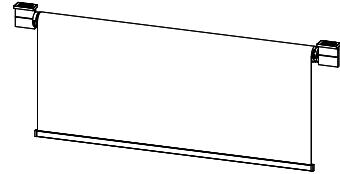

—
 Picture:
Simply / Top

—
 Finishes:
Pure White 9010

—
 Fabrics:
5190/10

Finishes

Finiture

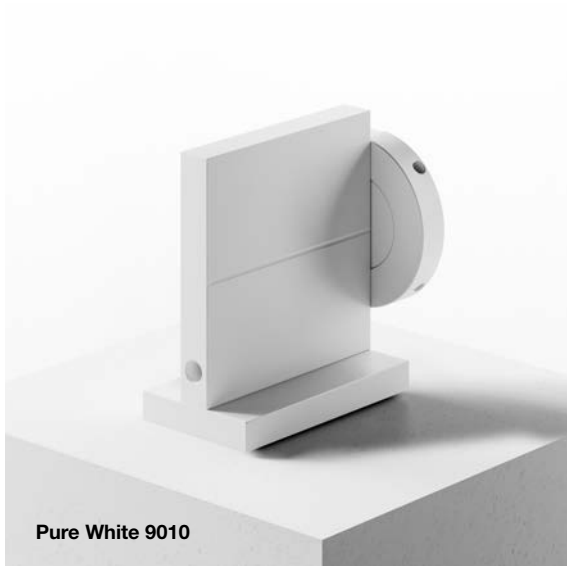

A support that dominates the space, standing out for the simple yet pronounced character of its geometry.

Un supporto che domina l'ambiente, dove spicca per il carattere semplice e marcato delle sue geometrie.





Simply

Ekstro

Installation

Suspended system
In sospensione

Type

Single or combined version
Singolo o abbinato

Product variants

L-shaped hook on wall
*Aggancio laterale a muro
a forma di L*

Operation

Moved by chain
or motorised system
A catena, a motore

Lowering of the fabric

Behind the roller
*Discesa del telo:
dietro l'avvolgibile*

Fabrics

Fabrics with different covering
properties, sound-absorbing
fabrics, printed fabrics and
for video projection
*Tessuti con diversi gradi di copertura,
tessuti fonoassorbenti, tessuti
stampati e per proiezioni video*

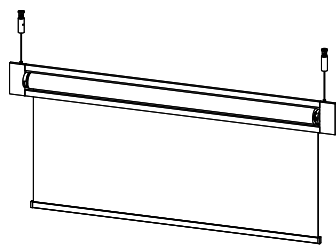

Technical info

→| P. 71





—
Picture:
Ekstro

—
Finishes:
Light Silver

—
Fabrics:
5101/57



Finishes *Finiture*



Pure White 9010

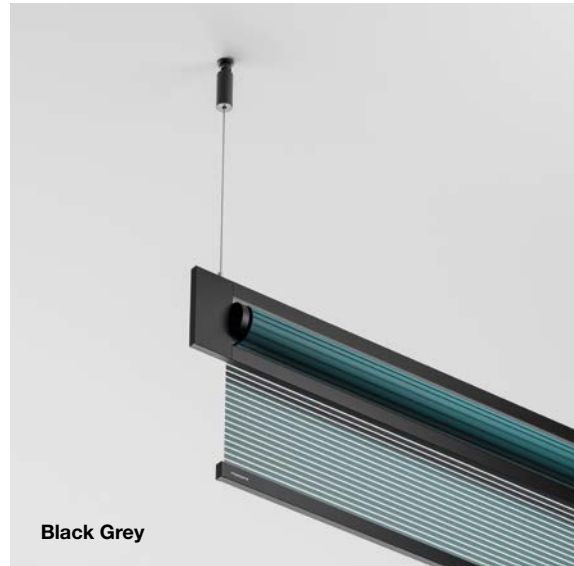

Black Grey



Light Silver

With its steel cables, Ekstro comes into its own in the most complicated installations: on sloped ceilings, for blinds set very close together, or as a room divider.

Grazie ai cavetti d'acciaio, Ekstro si presta alle installazioni più estreme: su soffitti inclinati, con teli abbinati a distanza minima o come divisorio d'ambiente.

Trej

Installation

On ceiling, on wall mounted
or with side fixing
*A soffitto, a parete o con attacco
laterale a parete*

Type

Single or combined version
Singolo o abbinato

Product variants

Double rollers with two variations
in the overhang, angular supports
*Doppio con due livelli di sporgenza,
supporto angolare*

Operation

Moved by chain
or motorised system
A catena, a motore

Lowering of the fabric

Standard in front of the roller
*Discesa del telo: standard
davanti all'avvolgibile*

Fabrics

Fabrics with different covering
properties, sound-absorbing
fabrics, printed fabrics and
for video projection
*Tessuti con diversi gradi di copertura,
tessuti fonoassorbenti, tessuti
stampati e per proiezioni video*

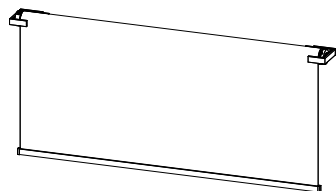

Technical info

→ P. 72





Picture:
Trej / Wall Double

Finishes:
DuPont™ Corian®

Fabrics:
5190/10 – 5147/10



Finishes *Finiture*



Whether it involves niches, corners, protruding handles, double or combined blinds, every technical requirement can find a solution in Trej, and will be expressed with character thanks to the range of finishes available.

Che si tratti di nicchie, angoli, maniglie sporgenti, teli doppi o abbinati, ogni esigenza tecnica con Trej trova una risposta e la interpreta con carattere grazie alle varie finiture disponibili.



Groove

Installation

Hidden into plaster ceiling
A scomparsa nel controsoffitto

Type

Single or combined version
Singolo o abbinato

Product variants

Corner combination
Combinazione ad angolo

Operation

Moved by chain or
 motorised system
A catena, a motore

Lowering of the fabric

Standard in front of the roller
*Discesa del telo: standard
 davanti all'avvolgibile*

Fabrics

Fabrics with different covering
 properties, sound-absorbing
 fabrics, printed fabrics and
 for video projection
*Tessuti con diversi gradi di copertura,
 tessuti fonoassorbenti, tessuti
 stampati e per proiezioni video*

Technical info

→| P. 78

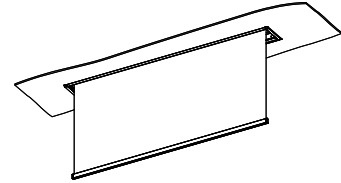

—
 Picture:
Groove

—
 Finishes:
Light Silver

—
 Fabrics:
5175/10

Finishes

Finiture



An aesthetically pleasing blend of linear geometry. Groove is an expression of the most contemporary tastes with the essential design of its frame, available in white and steel.

Sintesi estetica e geometrie lineari. Groove interpreta il gusto più contemporaneo con l'essenzialità progettuale della sua cornice, disponibile in bianco e acciaio.



Flexy

Installation

Ceiling or wall mounted
A soffitto o a parete

Type

Single or combined version
Singolo o abbinato

Product variants

Double rollers with two variations
 in the overhang, angular supports
*Doppio con due livelli di sporgenza,
 supporto angolare*

Operation

Moved by chain
 or motorised system
A catena, a motore

Lowering of the fabric

Standard in front of the roller
*Discesa del telo: standard
 davanti all'avvolgibile*

Fabrics

Fabrics with different covering
 properties, sound-absorbing
 fabrics, printed fabrics and
 for video projection
*Tessuti con diversi gradi di copertura,
 tessuti fonoassorbenti, tessuti
 stampati e per proiezioni video*

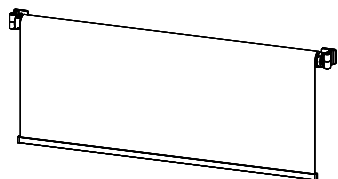

Technical info

→ P. 80





—
Picture:
Flexy / Wall

—
Finishes:
Light Silver

—
Fabrics:
5081/13



Finishes

Finiture



A product that has made Mycore's history. Versatile and eclectic, Flexy can adapt to curved walls and other architectural challenges, elegantly furnishing spaces in a variety of styles and shapes.

Un prodotto che ha fatto la storia di Mycore. Versatile ed eclettico, Flexy si adatta a pareti curve e altre insidie architettoniche, vestendo con eleganza spazi diversi per gusto e conformazione.

Quaver

Installation

On ceiling, on wall or
on window frame mounted
A soffitto, a parete o sul serramento

Type

Single or combined version
Singolo o abbinato

Product variants

Double rollers with two variations
in the overhang, lowered version,
anchoring system for hollows
and limited spaces, side rails
(only for Quaver Wall Mini)
*Doppio con due livelli di sporgenza,
versione ribassata, installazione
in nicchia o in spazi ridotti, guide
laterali (solo per Quaver Wall Mini)*

Operation

Moved by chain
or motorised system
A catena, a motore

Lowering of the fabric

Standard in front of the roller
*Discesa del telo: standard
davanti all'avvolgibile*

Fabrics

Fabrics with different covering
properties, sound-absorbing
fabrics, printed fabrics and
for video projection
*Tessuti con diversi gradi di copertura,
tessuti fonoassorbenti, tessuti
stampati e per proiezioni video*

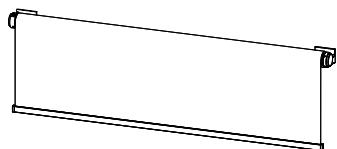

Technical info

→ P. 82





—
Picture:
Quaver / Wall

—
Finishes:
Pure White 9010

—
Fabrics:
5131/10



Finishes

Finiture



Pure White 9010



Black Grey



Light Silver



DuPont™ Corian®

A meticulous design made up of a combination of curved lines and angles for a decisive, dynamic visual effect. Quaver is a great solution for a wide range of architectural challenges.

Un design rigoroso, caratterizzato dall'accostamento di linee curve e angoli per un insieme visivo deciso e dinamico. Quaver è la soluzione per le più diverse criticità architettoniche.



Border

Installation

Ceiling or wall mounted
A soffitto o a parete

Type

Single or combined version
Singolo o abbinato

Product variants

Small lateral support
Supporto laterale ridotto

Operation

Moved by chain
 or motorised system
A catena, a motore

Lowering of the fabric

In front or behind the roller
*Discesa del telo: davanti
 o dietro all'avvolgibile*

Fabrics

Fabrics with different covering
 properties, sound-absorbing
 fabrics, printed fabrics and
 for video projection
*Tessuti con diversi gradi di copertura,
 tessuti fonoassorbenti, tessuti
 stampati e per proiezioni video*

Technical info

→| P. 88

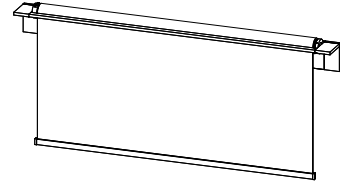

—
 Picture:
Border / Wall

—
 Finishes:
Light Silver

—
 Fabrics:
5193/07

Finishes

Finiture



A support that becomes a piece of furniture. Border makes itself the centre of attention with its marked personality and sculpted lines.

Un supporto che si fa elemento d'arredo. Border polarizza l'attenzione con la sua marcata personalità e le sue linee scolpite.





Border



“

**The details are not the details.
They make the design.**

*I dettagli non sono solo dettagli.
Sono essi stessi che creano il design.*

Charles Eames

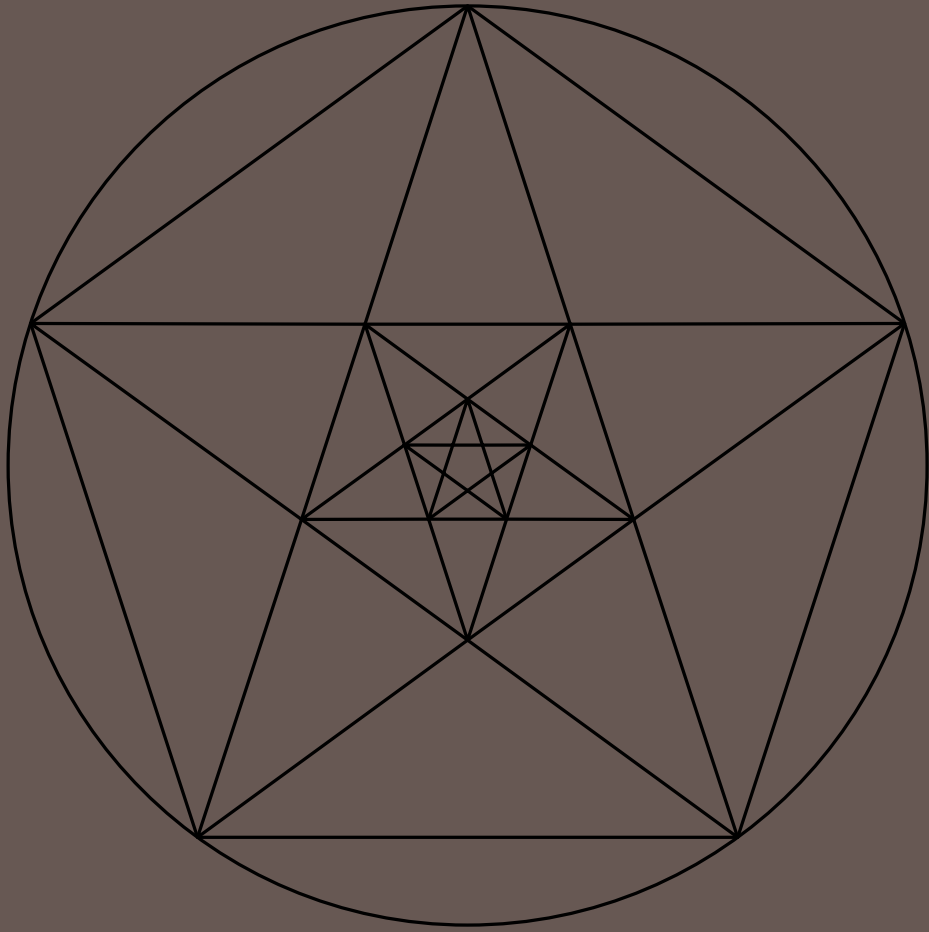

Solutions for every architectural requirement

Soluzioni per ogni esigenza architettonica

Mycore roller blind systems are able to meet even the most demanding architectural challenges, such as curved walls, sloped ceilings, corners or niches.

When these challenges exceed all expectations, the R&D department can develop ad hoc solutions thanks to a team of designers with two decades of experience and an in-house workshop, giving us the ability to provide new, unique responses to requirements on a case by case basis.

I sistemi di tende a rullo Mycore sono in grado di superare le sfide architettoniche più impegnative come pareti curve, soffitti inclinati, angoli o nicchie.

Quando queste si spingono oltre ogni previsione, il reparto R&D sviluppa soluzioni ad hoc grazie a un team di progettisti dall'esperienza ventennale e al laboratorio interno, in grado di fornire risposte mirate a esigenze di volta in volta uniche e nuove.

Phantom – 1

Standard

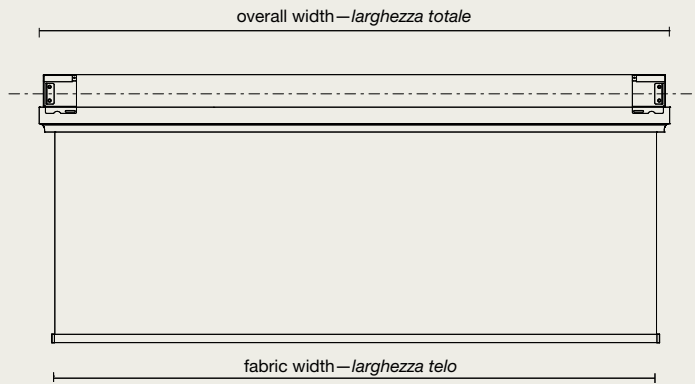

Corner combination Combinazione ad angolo

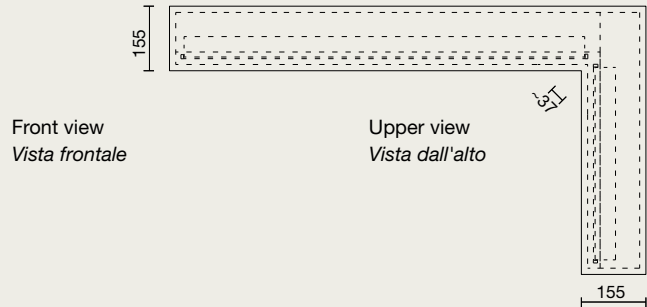

Version: SF Variante: SF

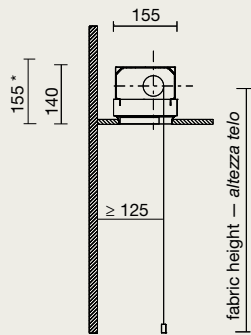

Lowering of the fabric:
in front of the roller (standard)
Discesa del telo: avanti (standard)

Version: SB Variante: SB

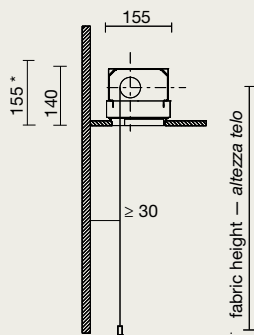

Lowering of the fabric:
behind the roller
Discesa del telo: dietro

Version: reduced false ceiling

Variante: controsoffitti di piccole dimensioni

Version: SF Variante: SF

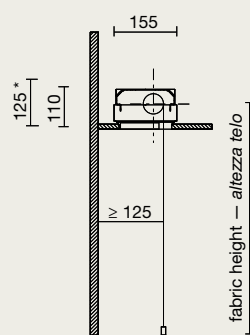

Lowering of the fabric:
in front of the roller (standard)
Discesa del telo: avanti (standard)

Version: SB Variante: SB

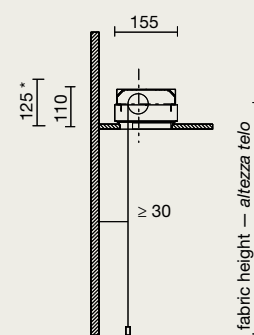

Lowering of the fabric:
behind the roller
Discesa del telo: dietro

Multiple combination Combinazione multipla

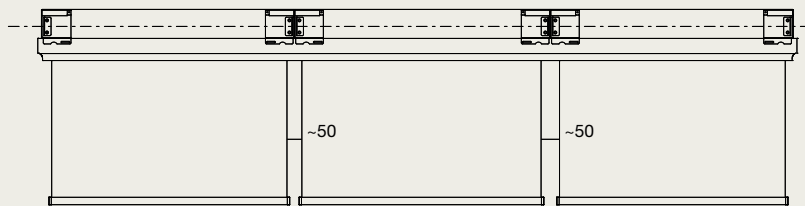

Front view
Vista frontale

Version: with side rails (custom) Variante: con guide laterali (su misura)

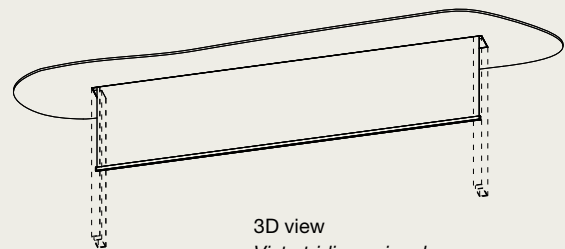

3D view
Vista tridimensionale

*Necessary space to install the system on wall (using wall cupboard fixing bar)
Spazio necessario per l'installazione a parete (con barra portapensile)

Maxi

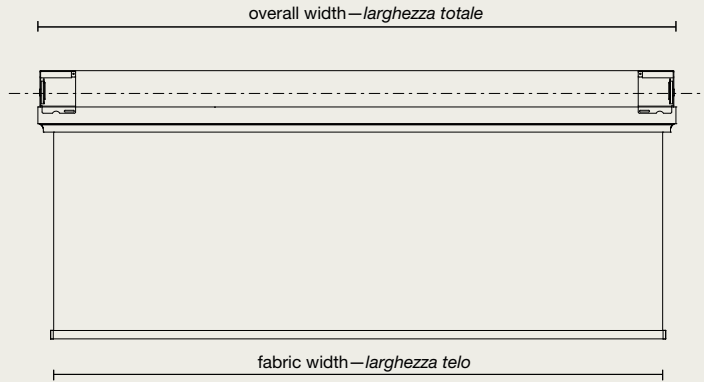

Corner combination Combinazione ad angolo

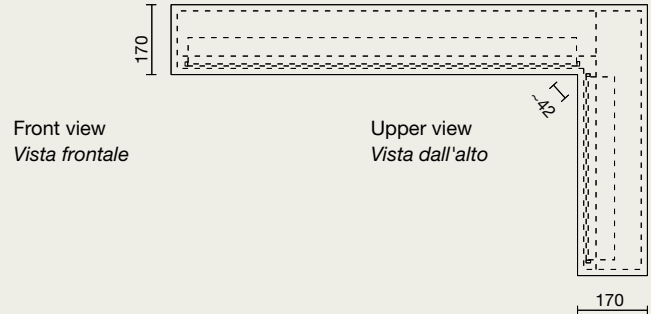

Version: SF Variante: SF

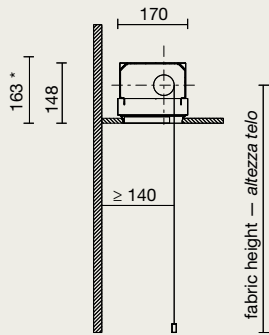

Lowering of the fabric:
in front of the roller (standard)
Discesa del telo: avanti (standard)

Version: SB Variante: SB

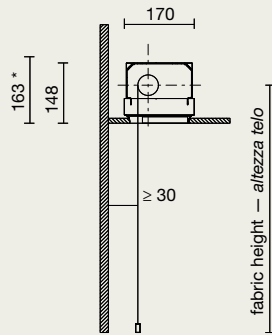

Lowering of the fabric:
behind the roller
Discesa del telo: dietro

Version: with side rails (custom) Variante: con guide laterali (su misura)

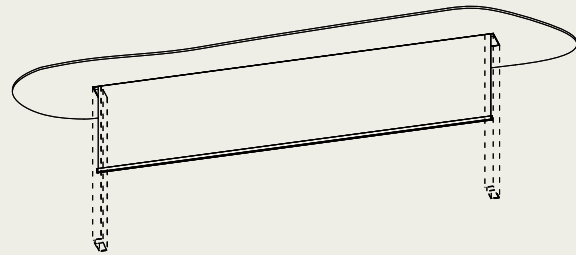

3D view
Vista tridimensionale

Multiple combination Combinazione multipla

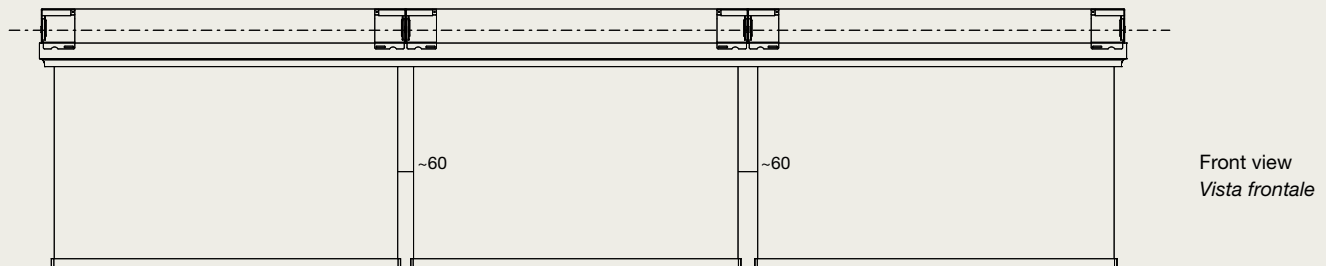

*Necessary space to install the system on wall (using wall cupboard fixing bar)
Spazio necessario per l'installazione a parete (con barra portapensile)

Phantom – 2

Double / Vertical



Corner combination Combinazione ad angolo

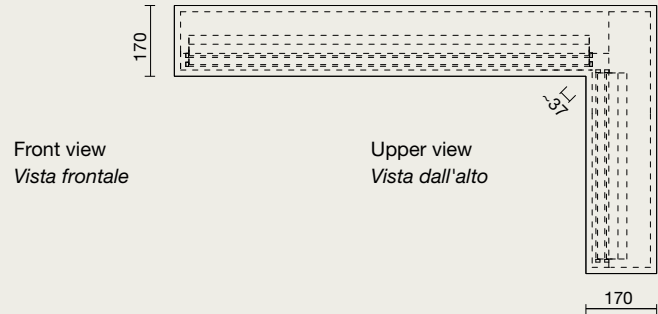

Version: DVB Variante: DVB

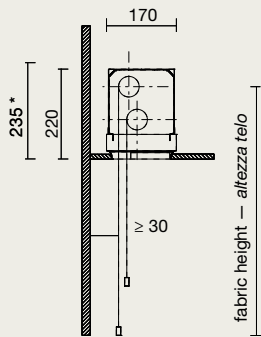

Lowering of the fabrics:
behind both rollers (standard)
Discesa dei teli: dietro (standard)

Version: DVF Variante: DVF

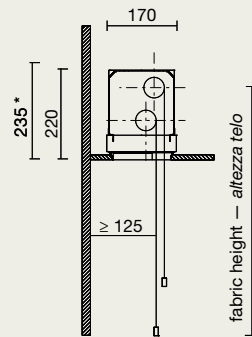

Lowering of the fabrics:
in front of both rollers
Discesa dei teli: avanti

Version: with side rails (custom) Variante: con guide laterali (su misura)

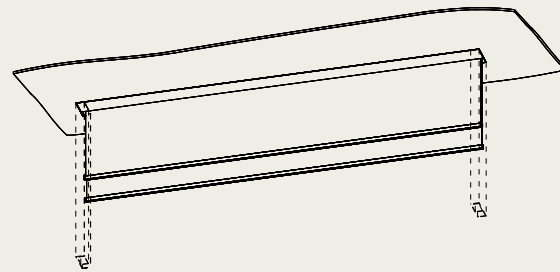

3D view
Vista tridimensionale

Multiple combination Combinazione multipla

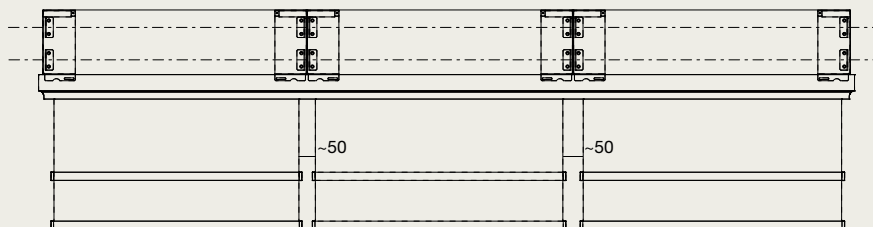

*Necessary space to install the system on wall (using wall cupboard fixing bar)
Spazio necessario per l'installazione a parete (con barra portapensile)

Double / Horizontal

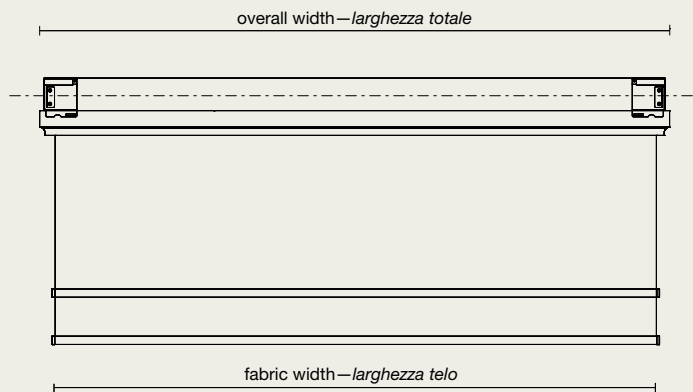

Front view
Vista frontale

Version: DOB

Variante: DOB

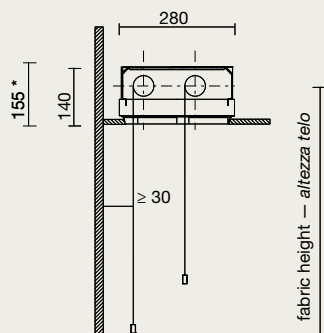

Lowering of the fabrics:
behind both rollers (standard)
Discesa dei teli: dietro (standard)

Version: DOM

Variante: DOM

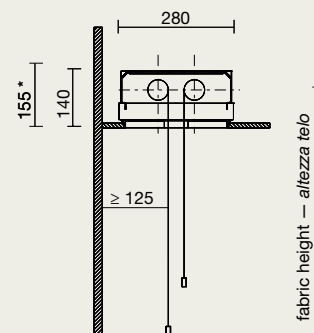

Lowering of the fabrics:
in the middle
Discesa dei teli: centrale

Multiple combination

Combinazione multipla

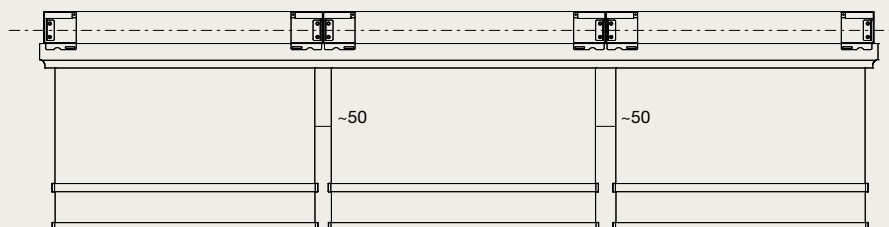

Front view
Vista frontale

*Necessary space to install the system on wall (using wall cupboard fixing bar)
Spazio necessario per l'installazione a parete (con barra portapensile)

Phantom — 3

One On One / Vertical

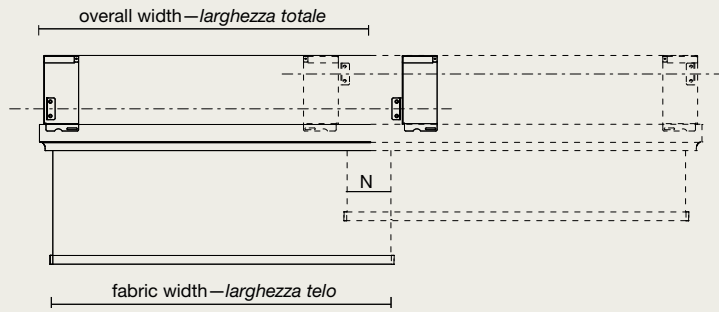

Front view
Vista frontale

Corner combination Combinazione ad angolo

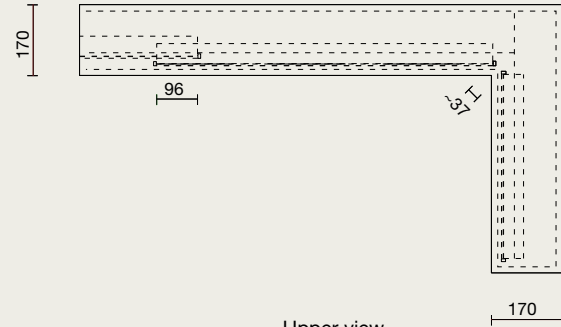

Upper view
Vista dall'alto

Version: NVF Variante: NVF

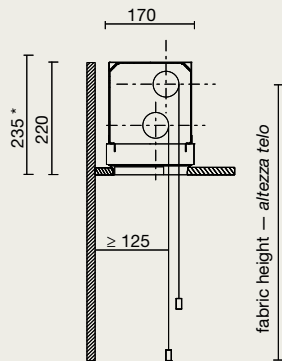

Lowering of the fabrics:
in front of both rollers (standard)
Discesa dei teli: avanti (standard)

Version: NVB Variante: NVB

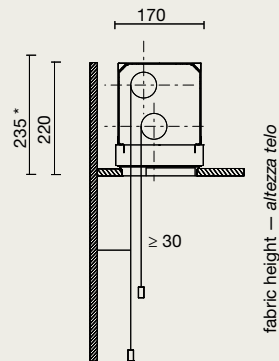

Lowering of the fabrics:
behind both rollers
Discesa dei teli: dietro

Multiple combination Combinazione multipla

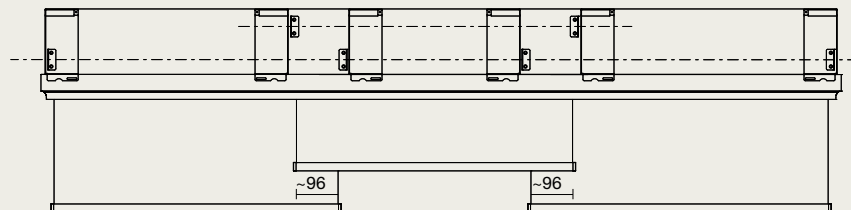

Front view
Vista frontale

*Necessary space to install the system on wall (using wall cupboard fixing bar)
Spazio necessario per l'installazione a parete (con barra portapensile)

One On One / Horizontal

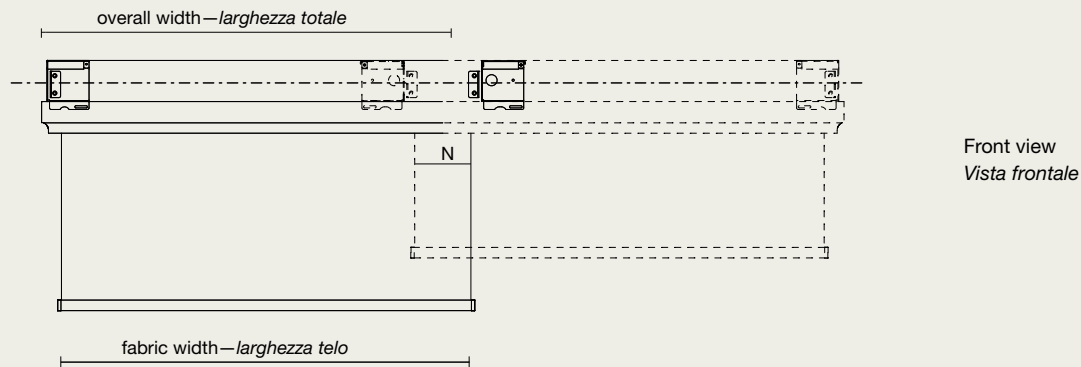

Version: NOM

Variante: NOM

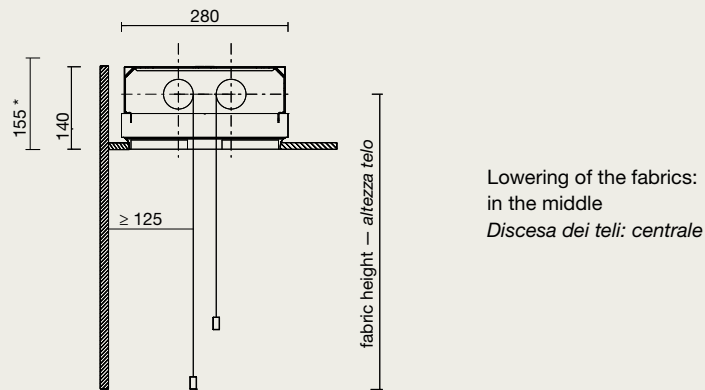

Multiple combination

Combinazione multipla

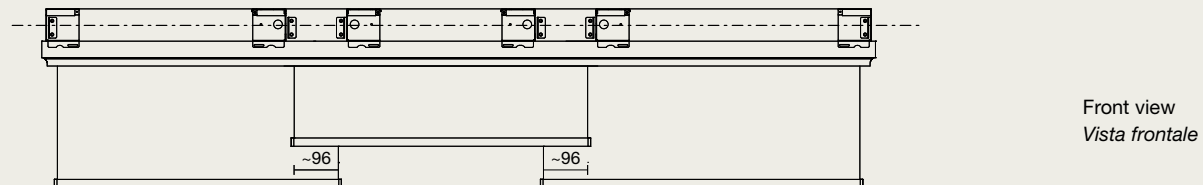

*Necessary space to install the system on wall (using wall cupboard fixing bar)
Spazio necessario per l'installazione a parete (con barra portapensile)

Simply – 1

Top

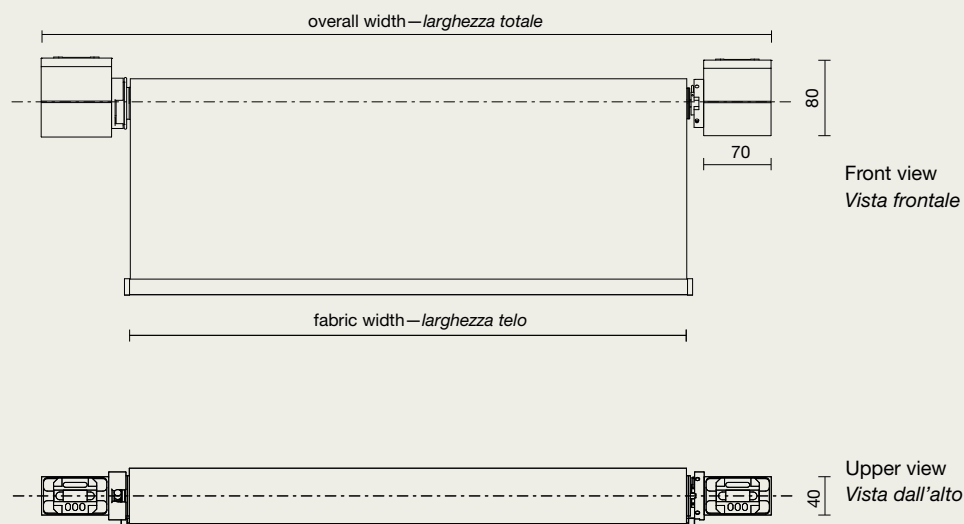

Single system Sistema singolo



Corner combination Combinazione ad angolo

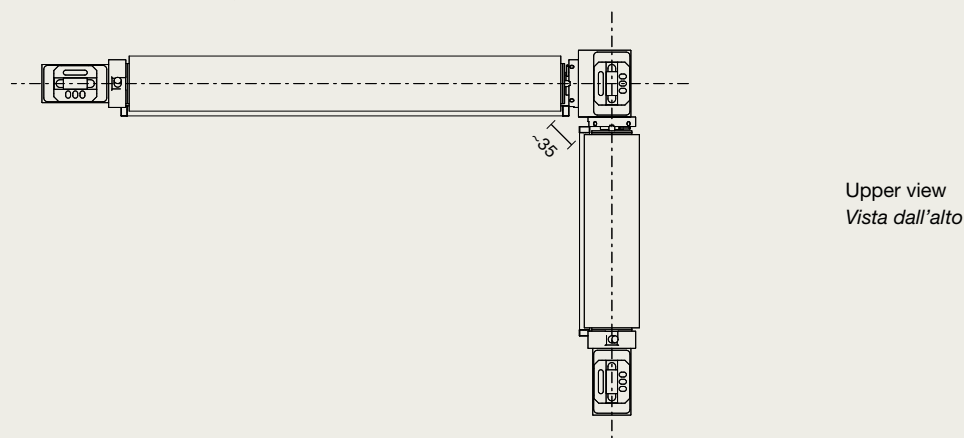

Multiple combination Combinazione multipla

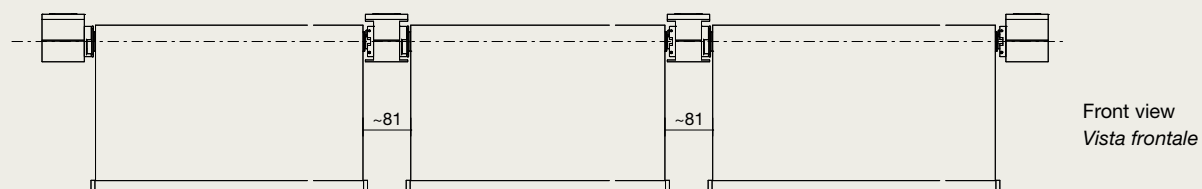

Wall

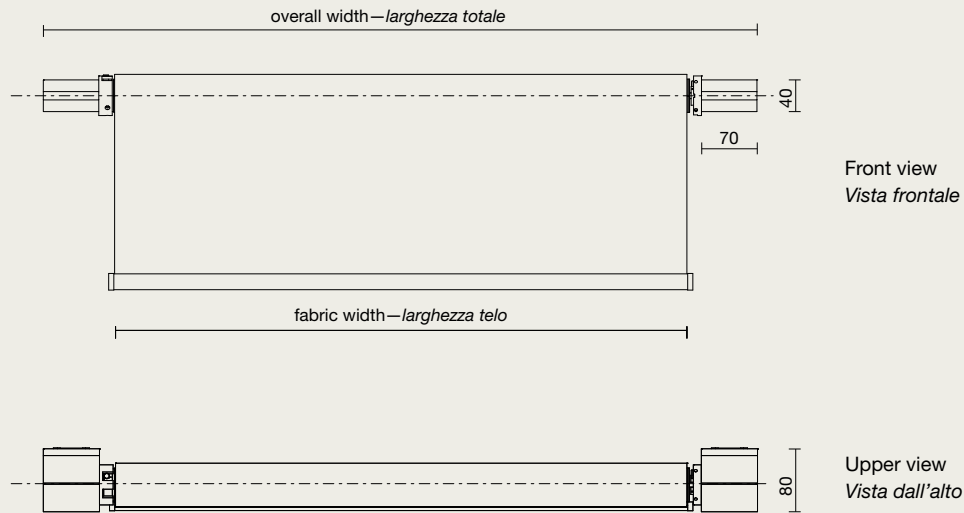

Single system Sistema singolo

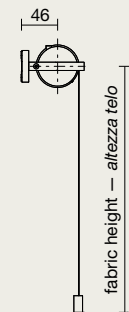

Corner combination Combinazione ad angolo



Double system Sistema doppio

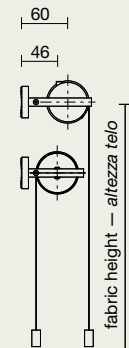

Multiple combination Combinazione multipla

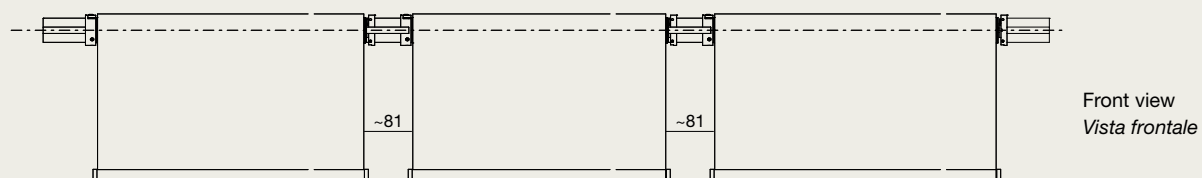

Simply – 2

Line

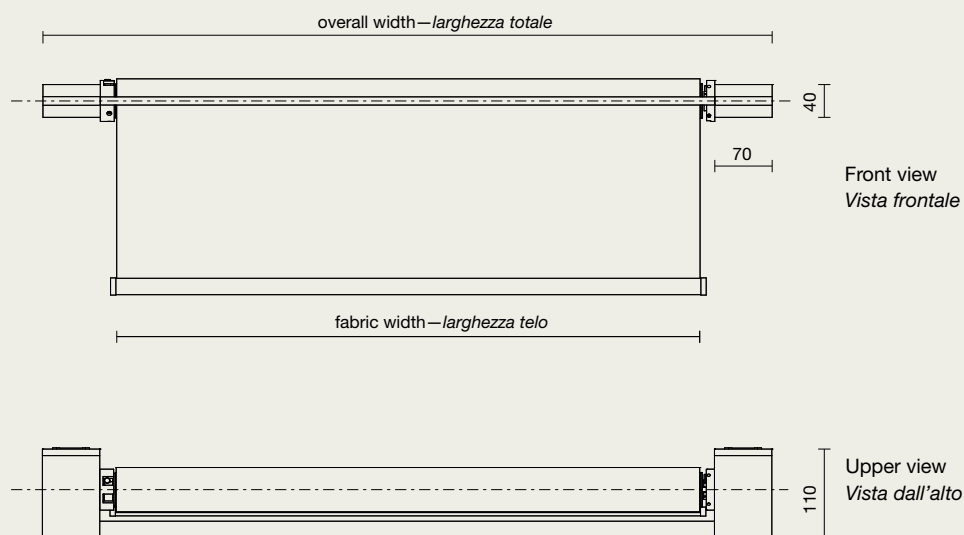

Single system Sistema singolo

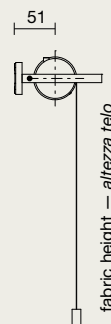

Multiple combination Combinazione multipla

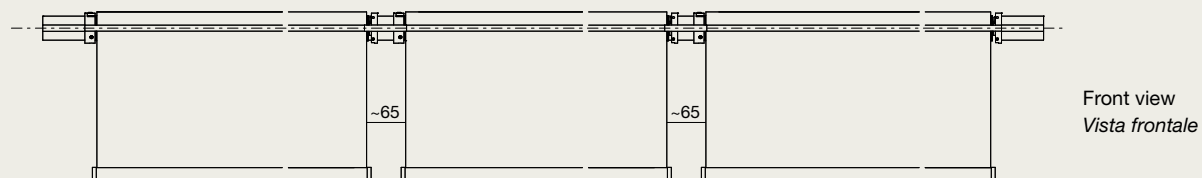

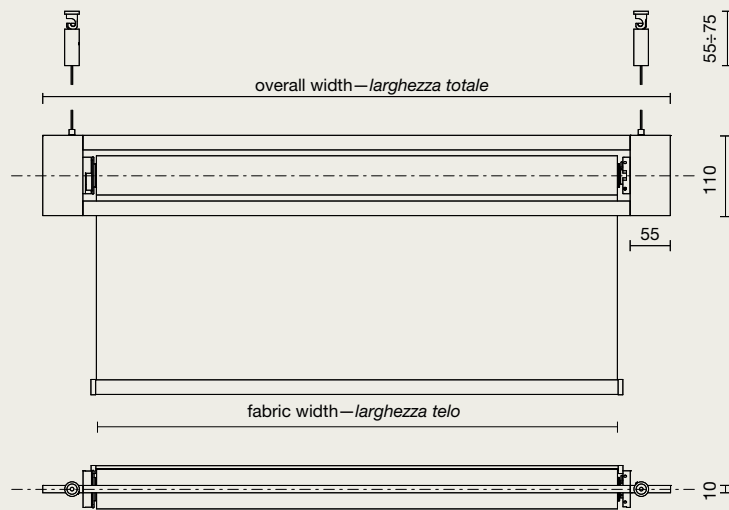
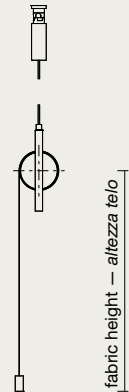
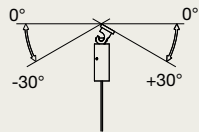
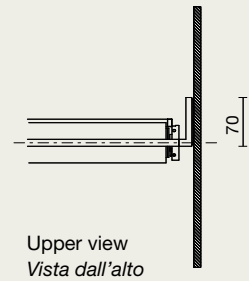
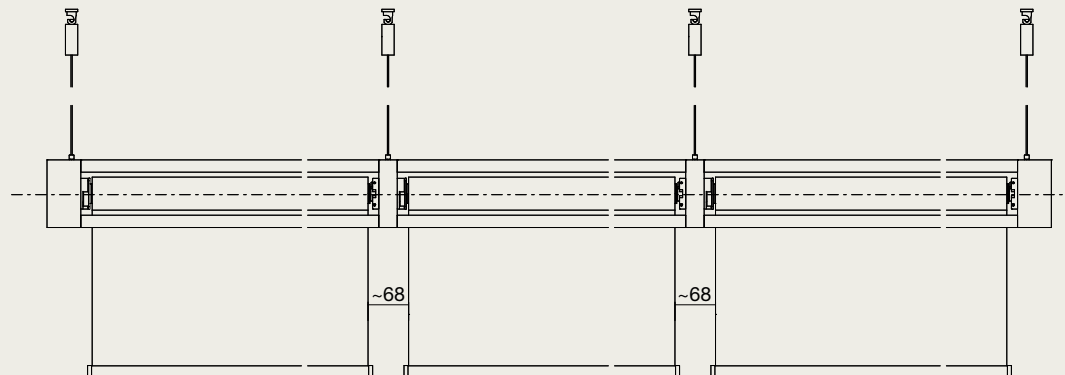
SuspendedFront view
Vista frontaleUpper view
Vista dall'alto**Single system**
Sistema singolo**Working area***Campo d'utilizzo***Version: L wall***Variante: L a muro*Upper view
Vista dall'alto**Multiple combination***Combinazione multipla*Front view
Vista frontale

Trej – 1

Assym

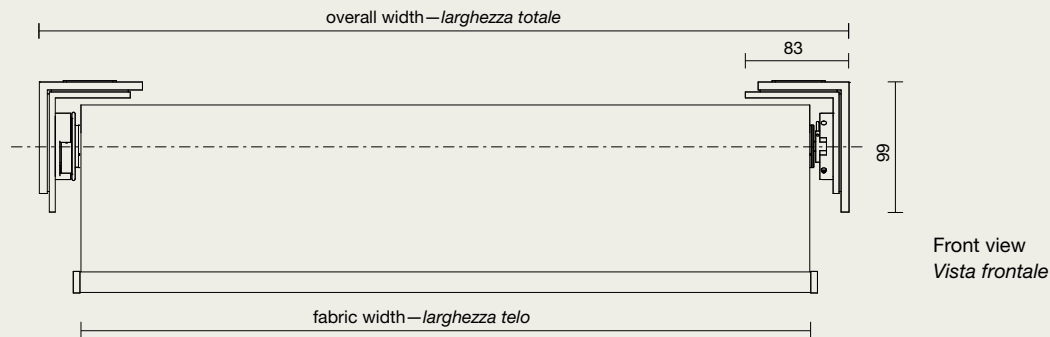

Single system Sistema singolo

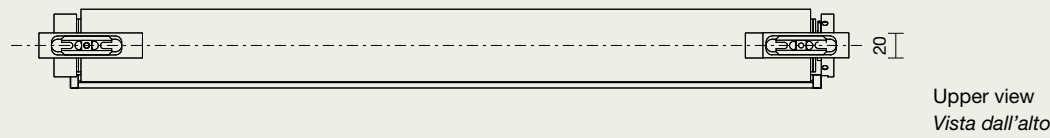
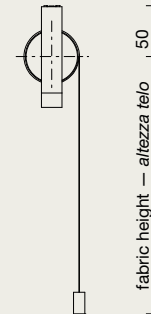

Corner combination Combinazione ad angolo

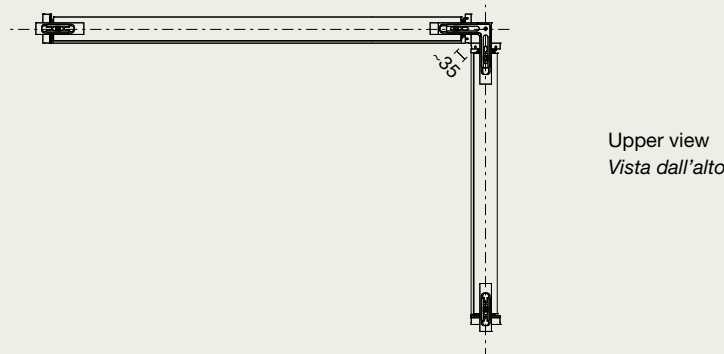

Multiple combination Combinazione multipla

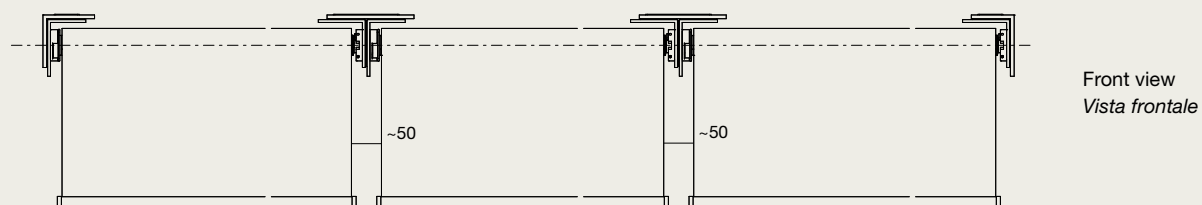

Wall

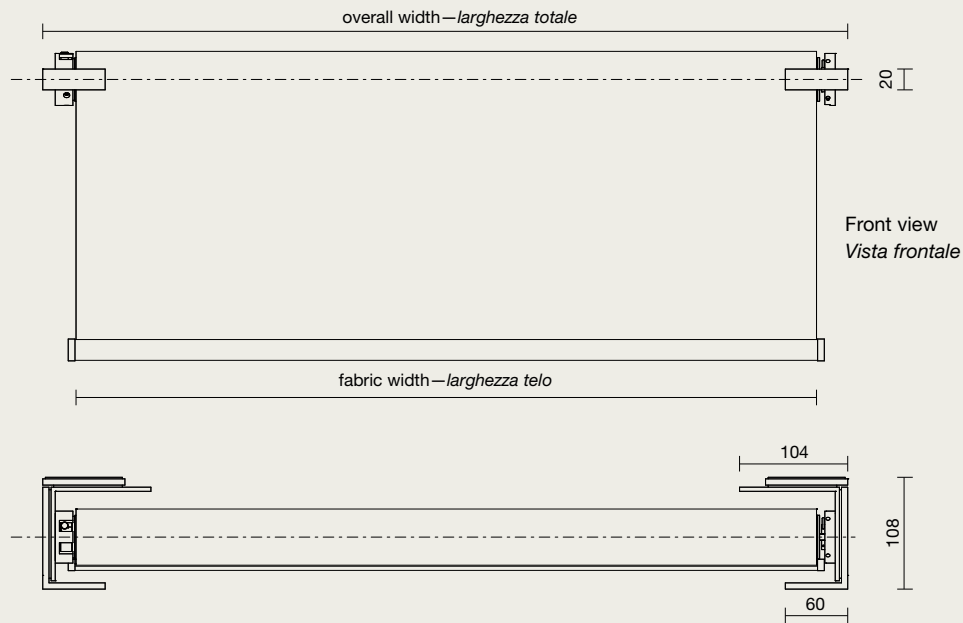

Single system Sistema singolo

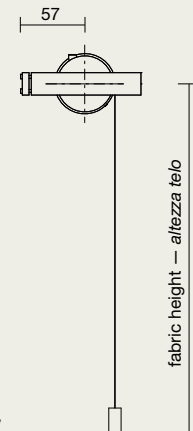

Corner combination Combinazione ad angolo

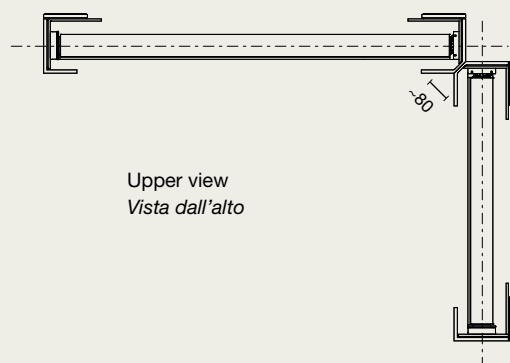

Double system Sistema doppio

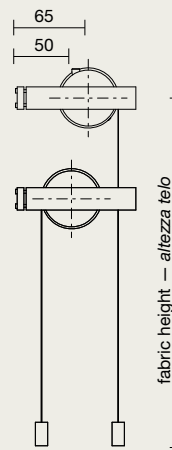

Without fixing plate
Senza piastra di fissaggio

Double system Sistema doppio

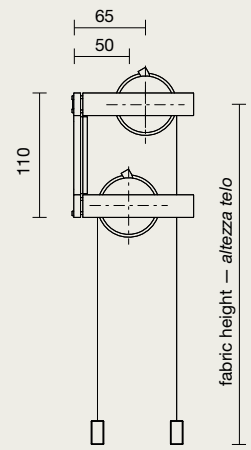

With fixing plate
Con piastra di fissaggio

Multiple combination Combinazione multipla

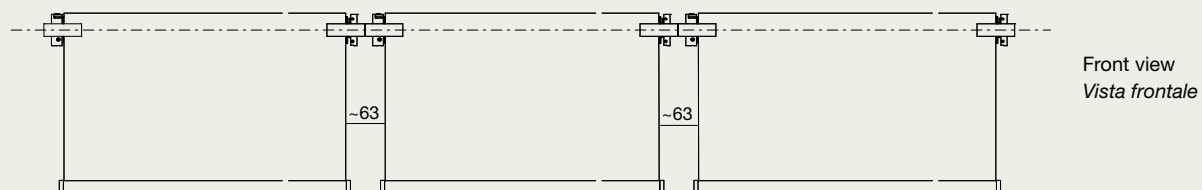

Trej – 2

Wall / Extended

Single system Sistema singolo

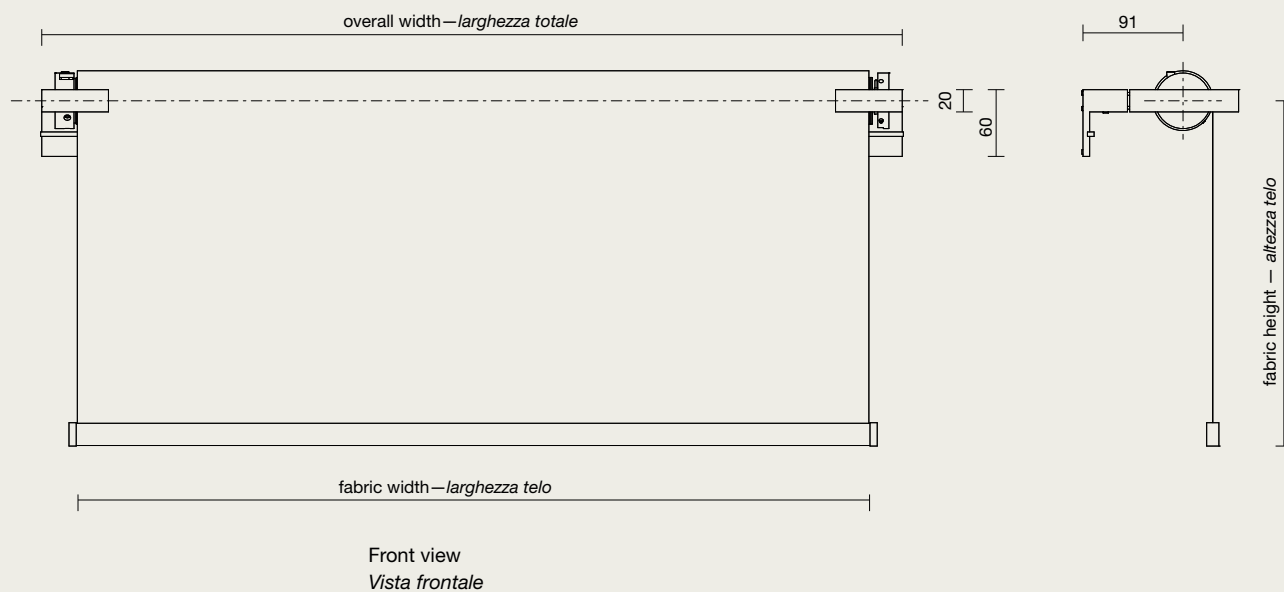

Multiple combination Combinazione multipla

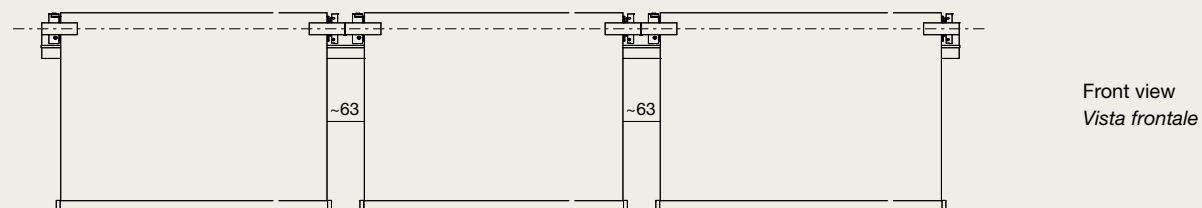

Wall / Extended / Double

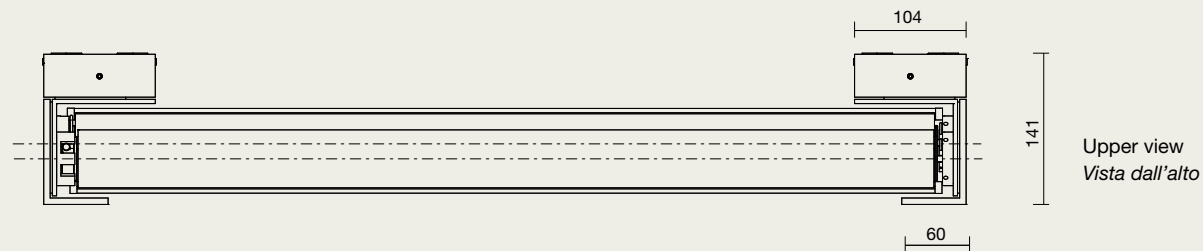
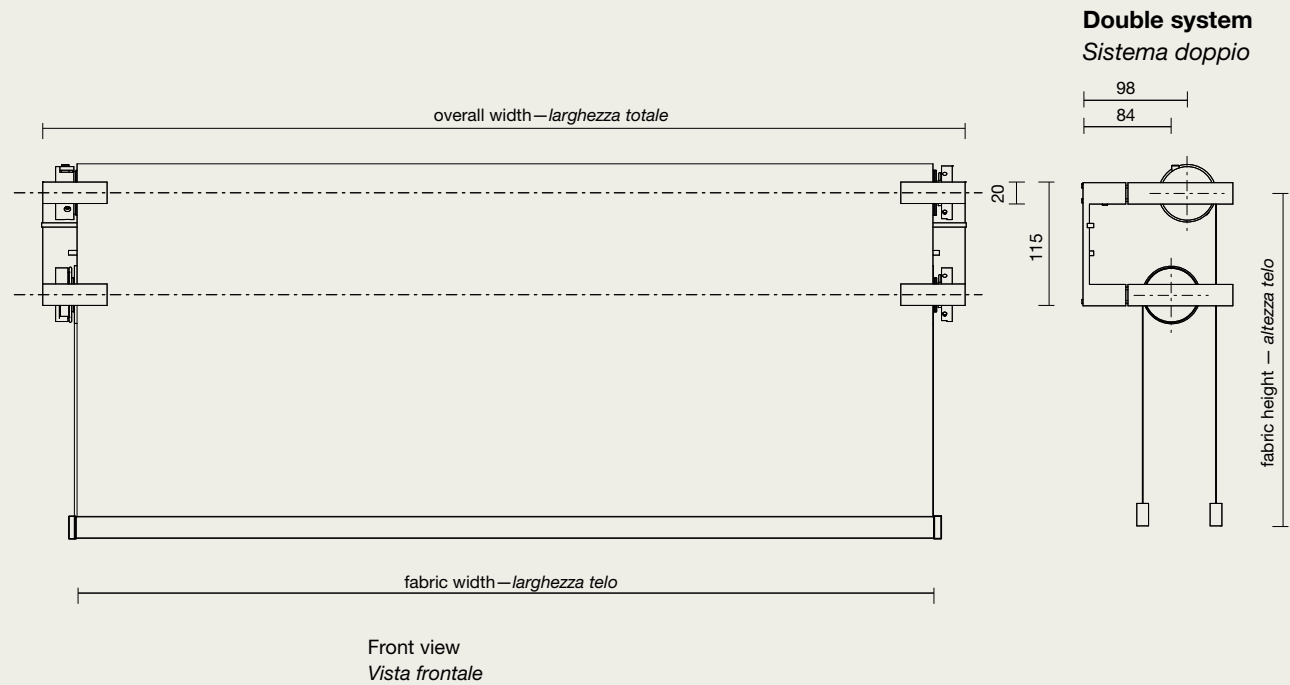

Multiple combination

Combinazione multipla

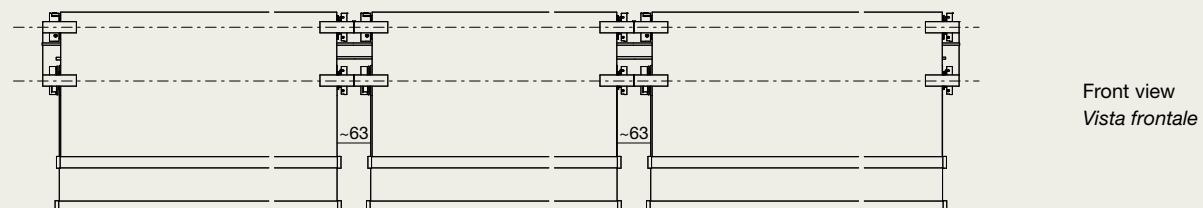

Trej — 3

Wall / Side

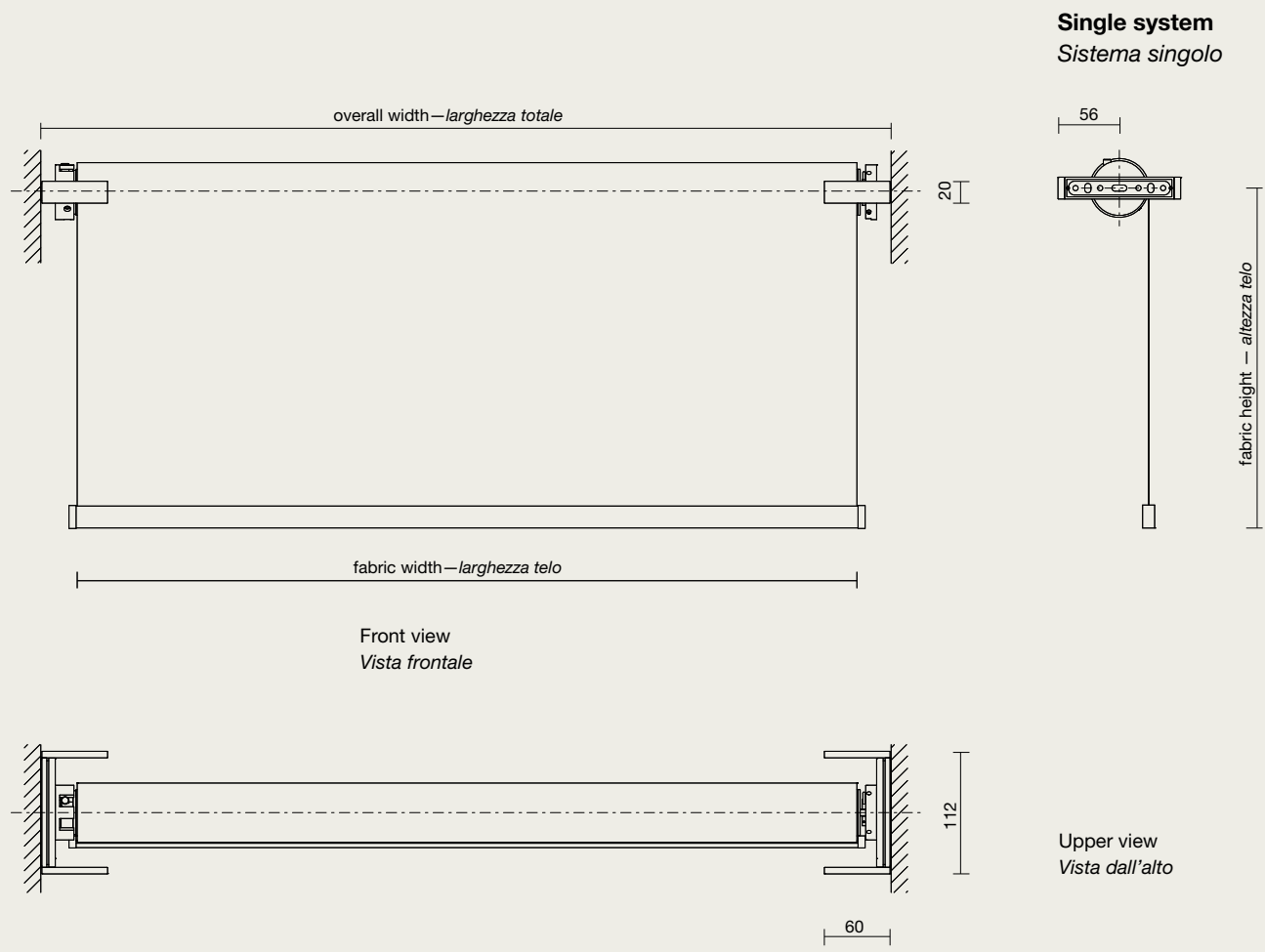

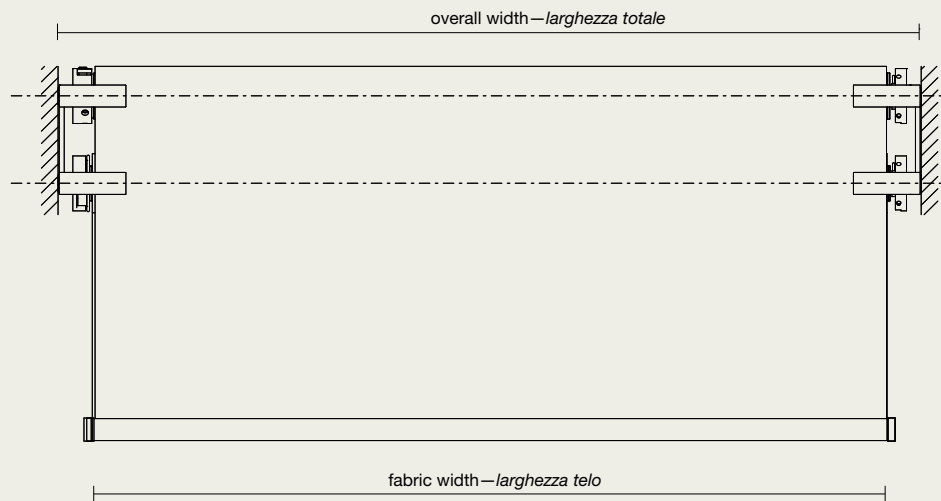
Wall / Side / Double

Front view
Vista frontale

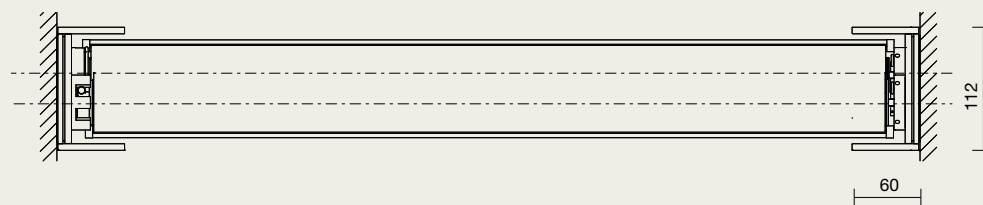
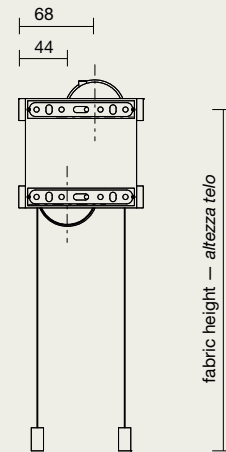
Double system
Sistema doppio

Upper view
Vista dall'alto

Groove

Standard

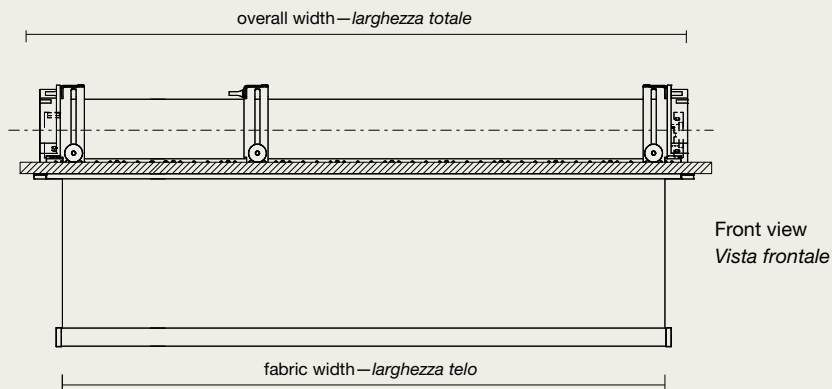

Version: SF
Variante: SF

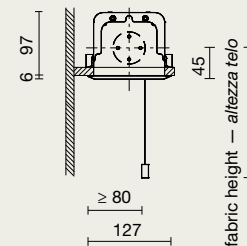

Lowering of the fabric:
in front of the roller (standard)
Discesa del telo: avanti (standard)

Corner combination
Combinazione ad angolo

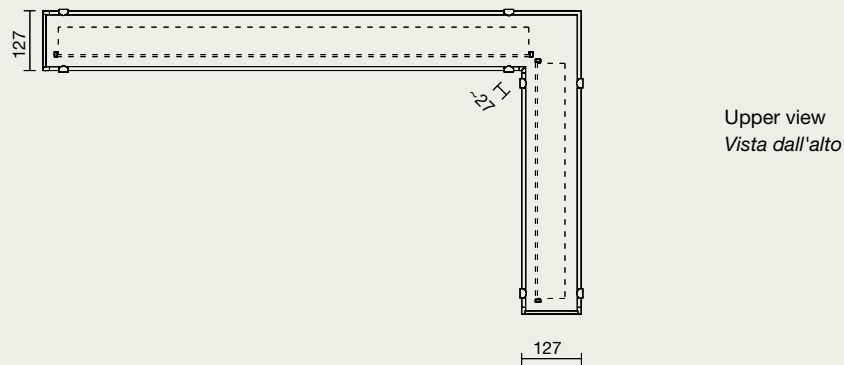

Version: SB
Variante: SB

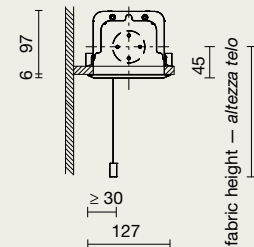

Lowering of the fabric:
behind the roller
Discesa del telo: dietro

Multiple combination
Combinazione multipla

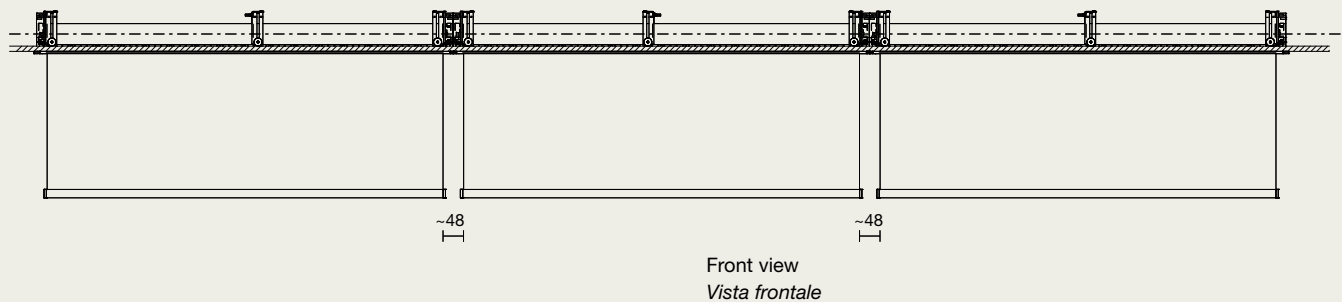

Double

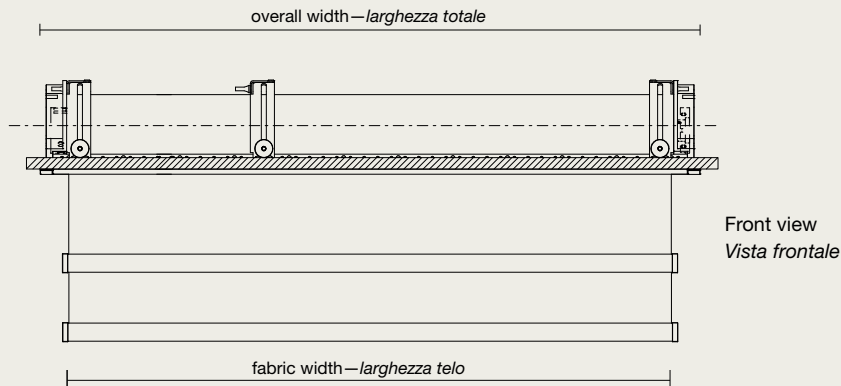

Version: DOB

Variante: DOB

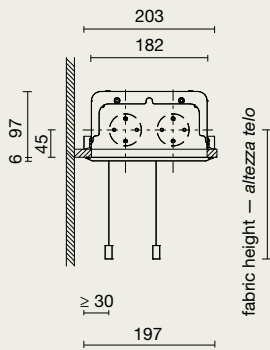

Lowering of the fabrics:
behind both rollers (standard)
Discesa dei teli: dietro (standard)

Version: DOM

Variante: DOM

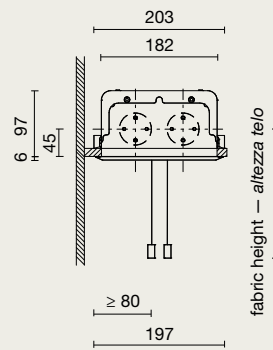

Lowering of the fabrics:
in the middle
Discesa dei teli: centrale

Multiple combination

Combinazione multipla

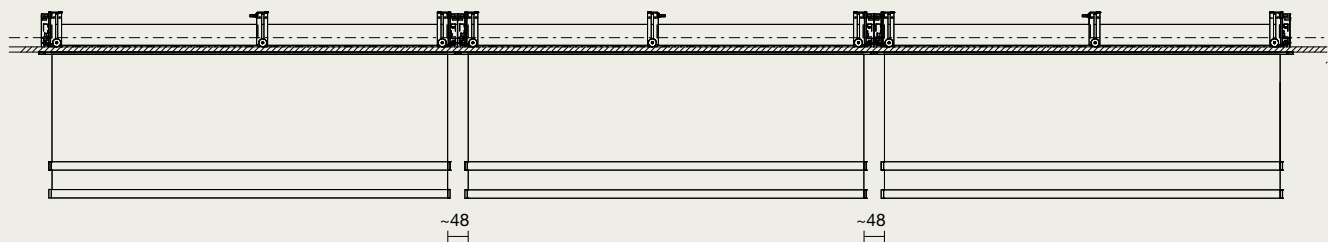

Flexy

Top

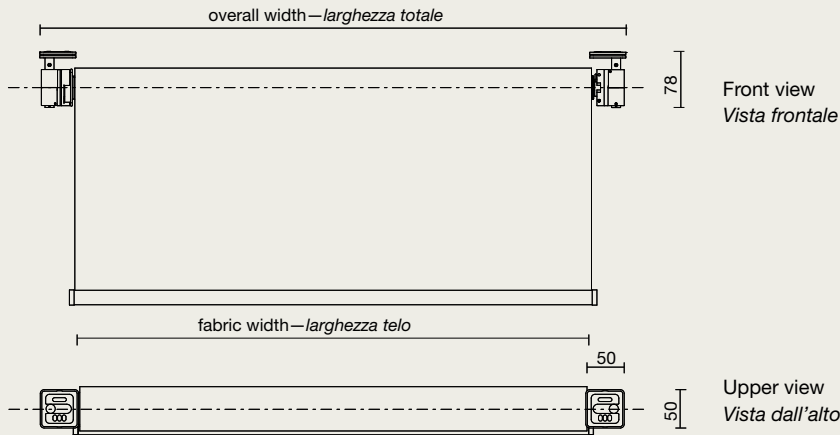

Single system Sistema singolo

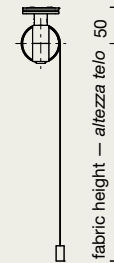

Working area

Campo d'utilizzo

Version: standard

Variante: standard

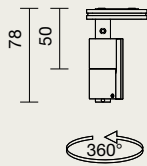

Version: telescopic support

Variante: supporto telescopico

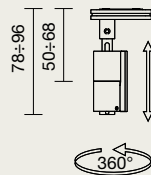

Version: adjustable support (Extreme)

Variante: supporto regolabile (Extreme)

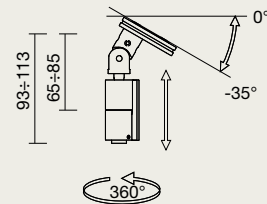

Corner combination

Combinazione ad angolo

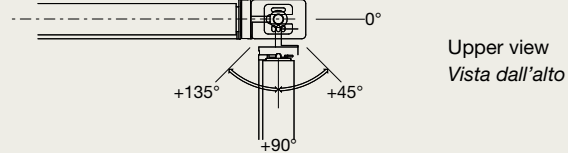
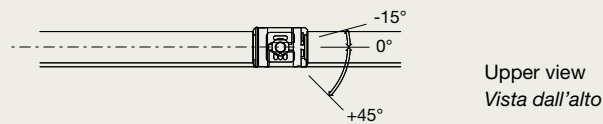

Multiple combination

Combinazione multipla

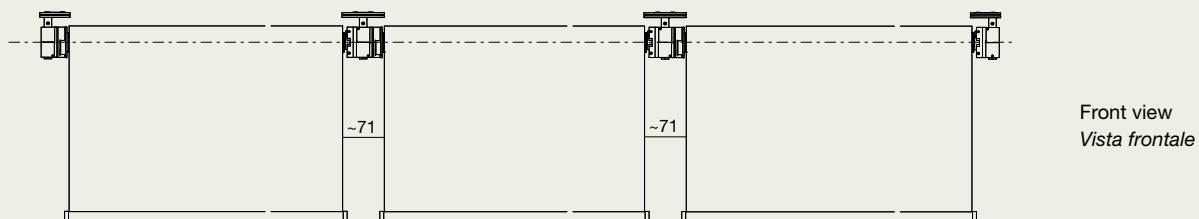

Wall

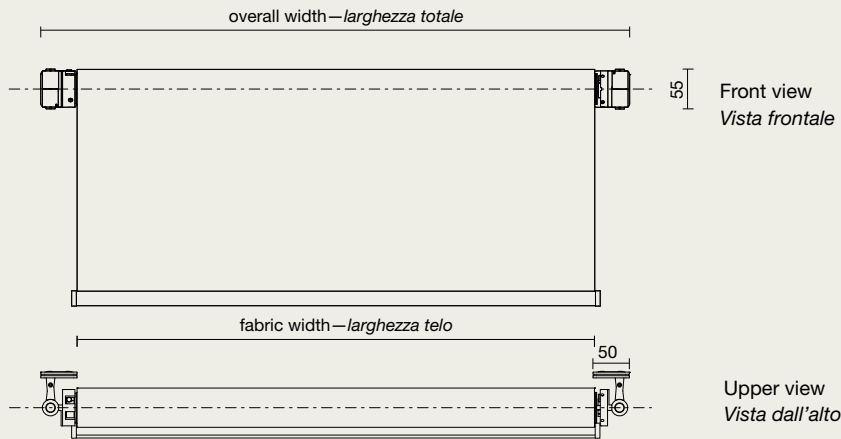

Single system Sistema singolo

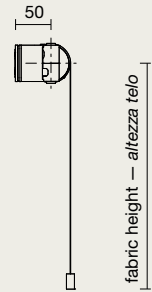

Working area Campo d'utilizzo

Version: A Variante: A

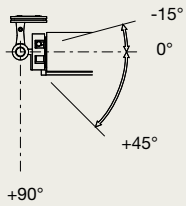

Version: B Variante: B

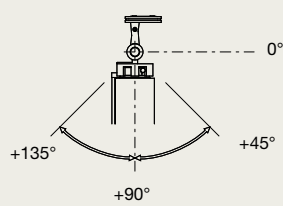

Double system Sistema doppio

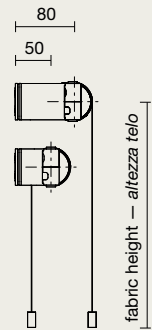

Corner combination Combinazione ad angolo

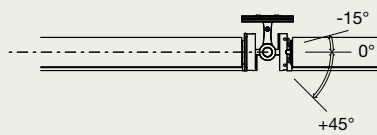

Upper view
Vista dall'alto

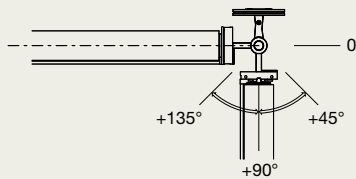

Upper view
Vista dall'alto

Multiple combination Combinazione multipla

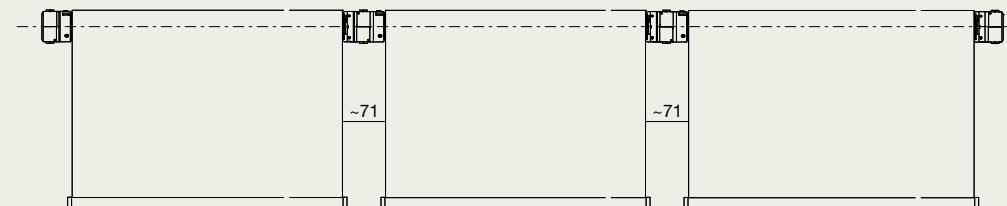

Front view
Vista frontale

Quaver – 1

Top

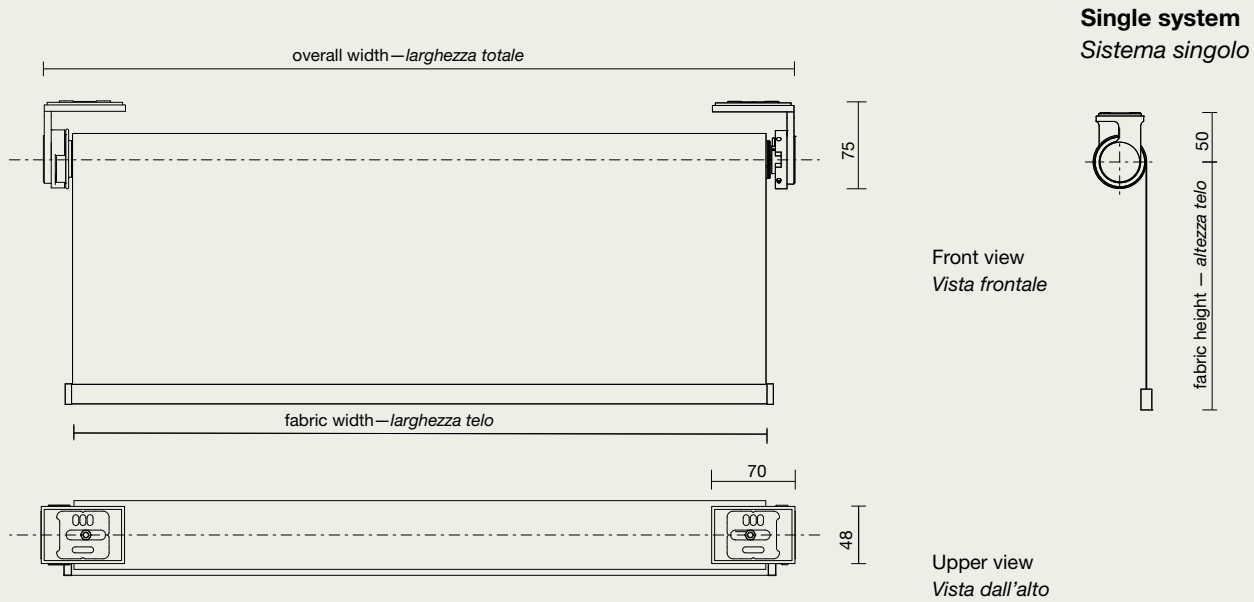

Lowered version* Versione ribassata

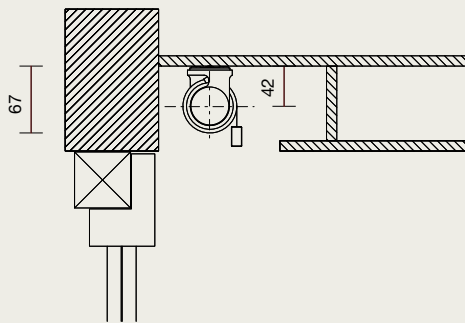

*Available only in Light Silver finish
Disponibile solo nella finitura Light Silver

Multiple combination Combinazione multipla

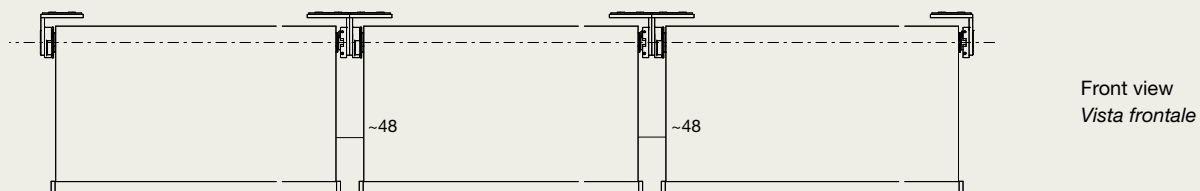

Wall

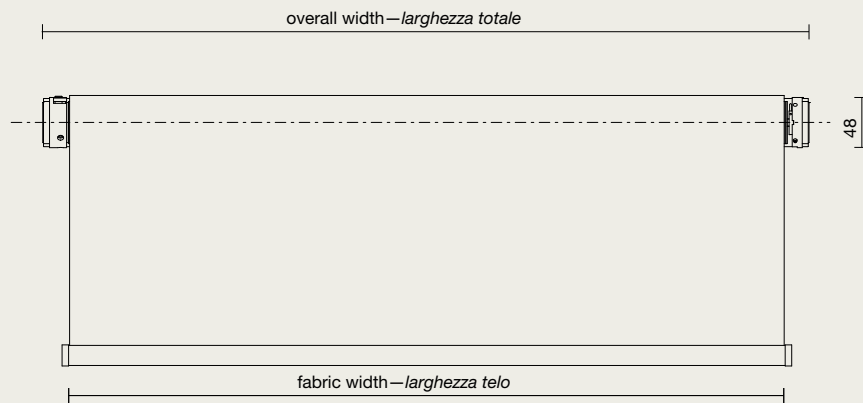

Front view
Vista frontale

Single system Sistema singolo

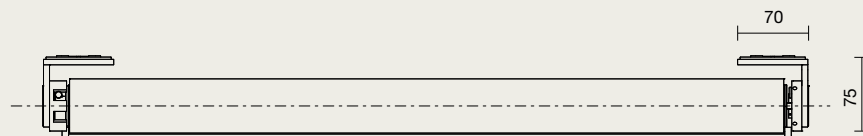

Upper view
Vista dall'alto

Double system Sistema doppio



Multiple combination Combinazione multipla

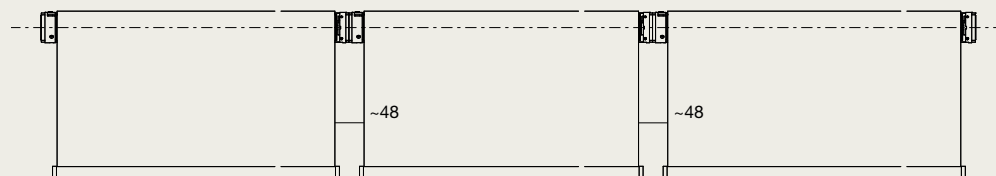

Front view
Vista frontale

Quaver – 2

Top / Maxi

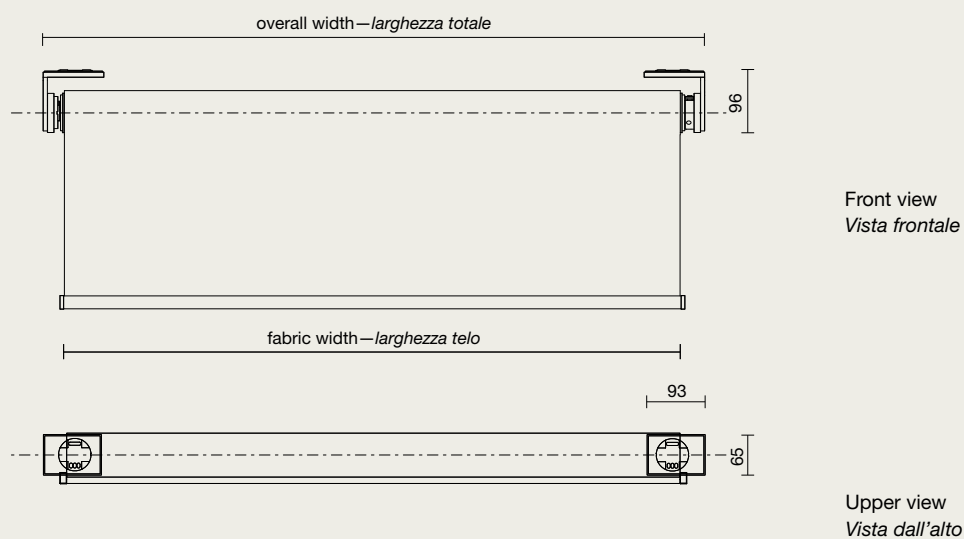

Single system Sistema singolo

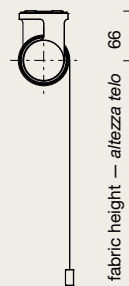

Version: anchoring system for hollows and limited spaces Variante: supporto per installazione in nicchia o in spazi ridotti



Multiple combination Combinazione multipla

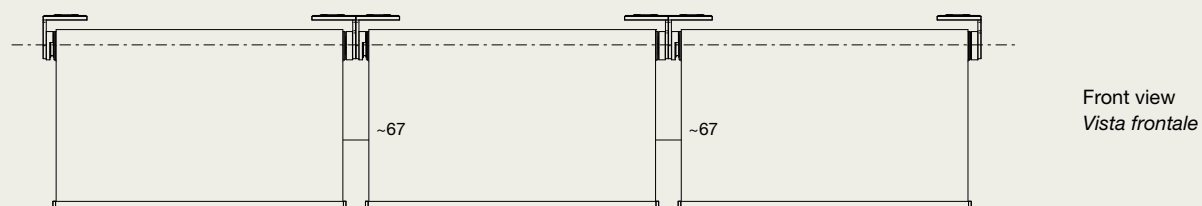

Wall / Maxi

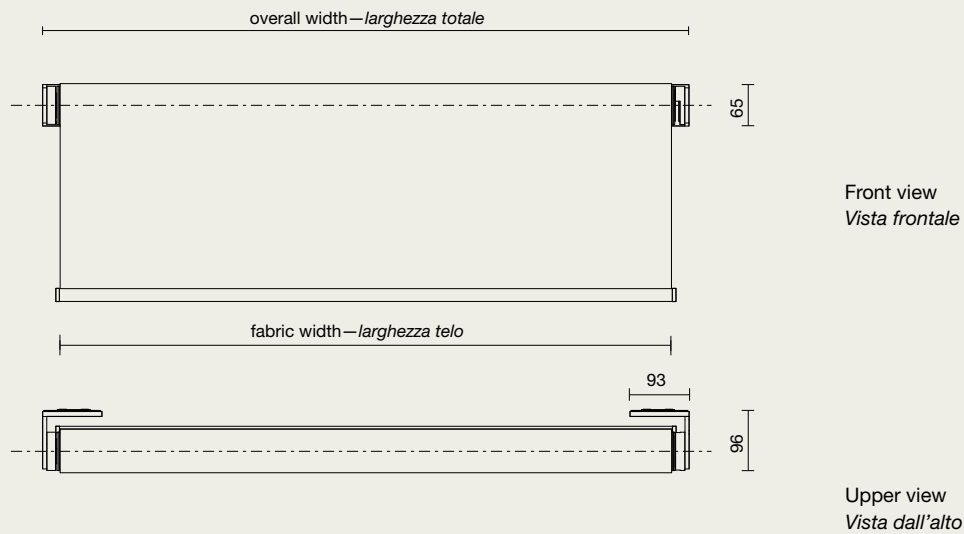

Single system Sistema singolo

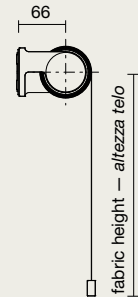

Version: anchoring system for hollows and limited spaces

Variante: supporto per installazione in nicchia o in spazi ridotti



Multiple combination

Combinazione multipla

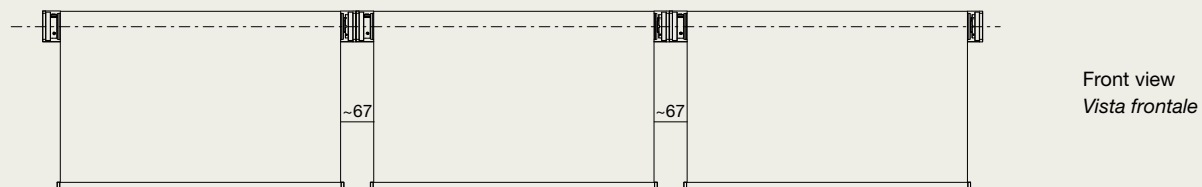

Quaver — 3

Top / Mini

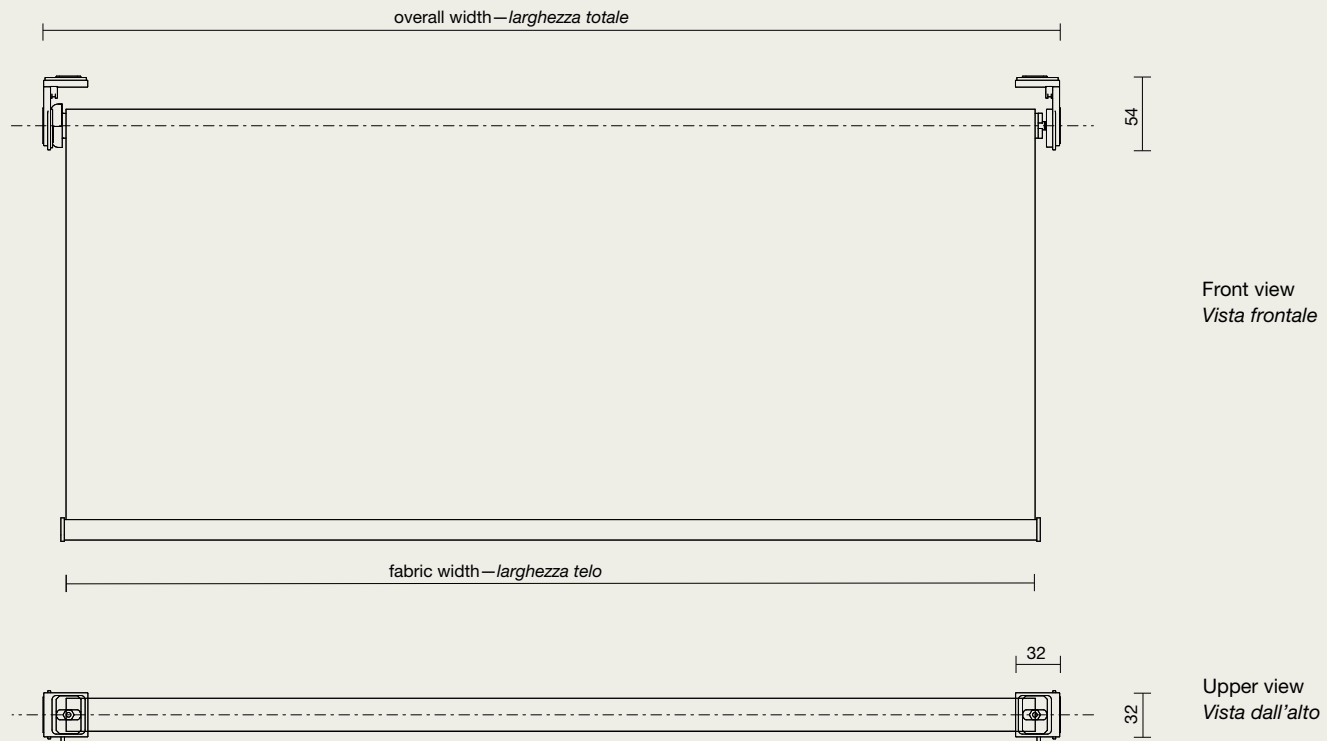

Single system Sistema singolo

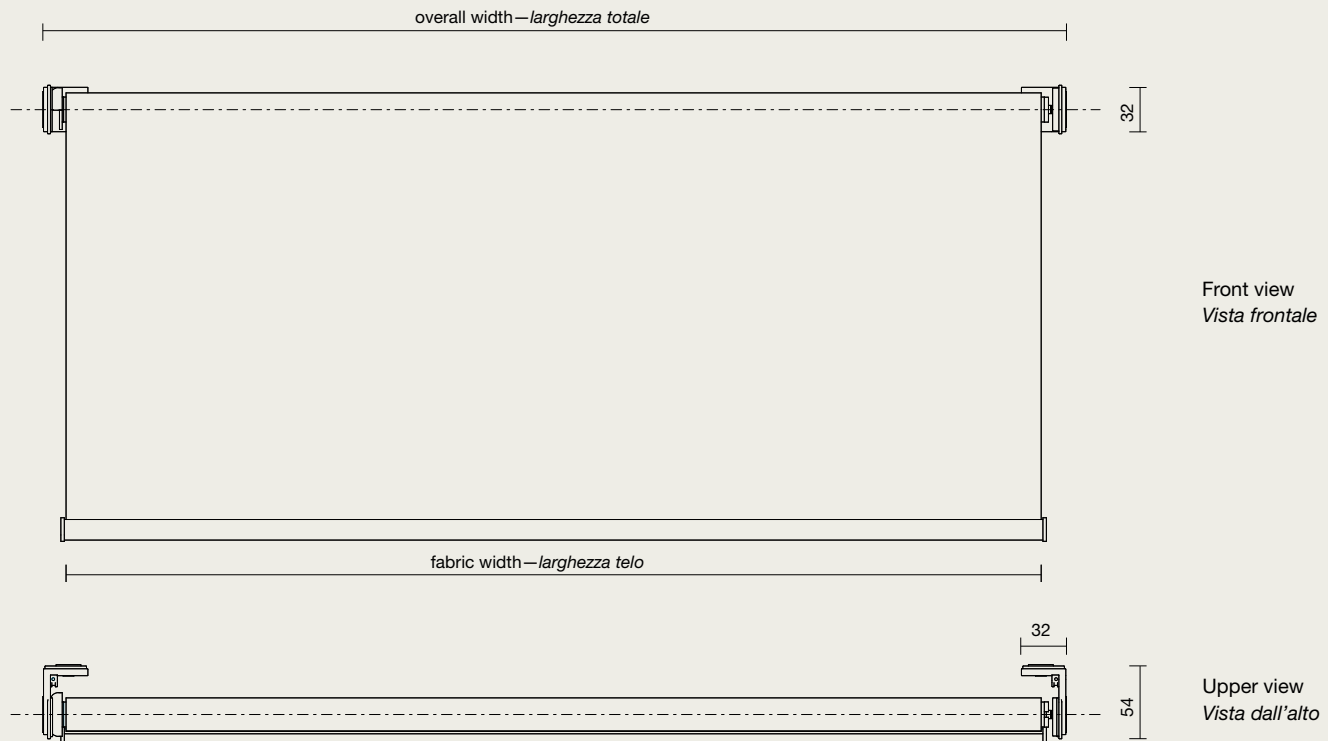
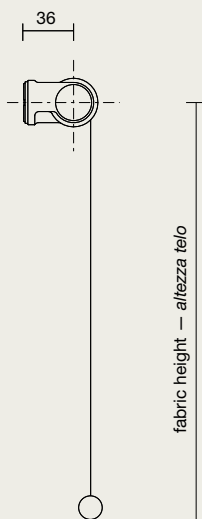
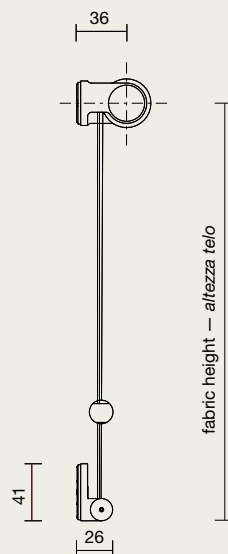

Wall / Mini**Single system**
Sistema singolo**Version with side rails**
Versione con guide laterali

Lowering of the fabric: only behind the roller
 Discesa del telo: solo dietro l'avvolgibile

Border

Top

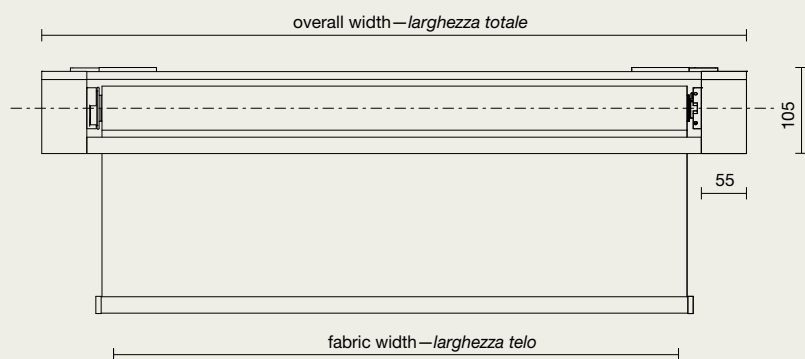

Front view
Vista frontale

Single system Sistema singolo

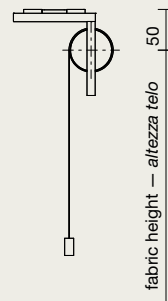

Version: small lateral support Variante: supporto laterale ridotto

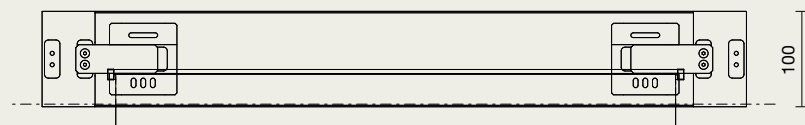

Upper view
Vista dall'alto

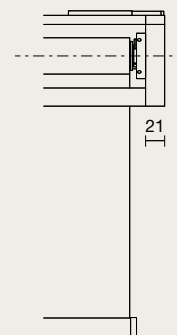

Front view
Vista frontale

Multiple combination Combinazione multipla



Front view
Vista frontale

Wall

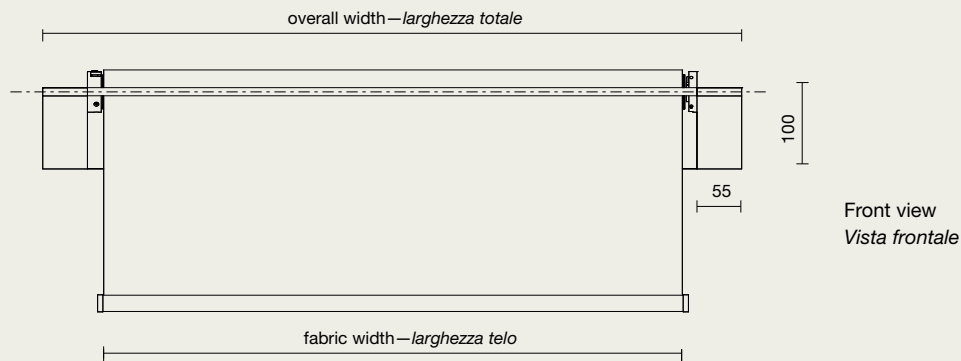

Single system Sistema singolo

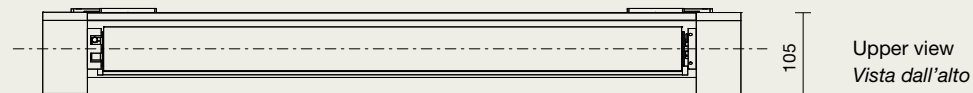
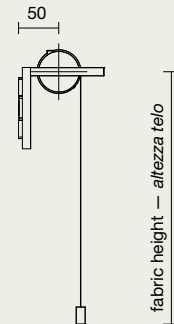

Version: small lateral support Variante: supporto laterale ridotto

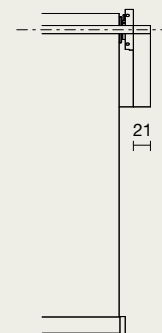

Multiple combination Combinazione multipla

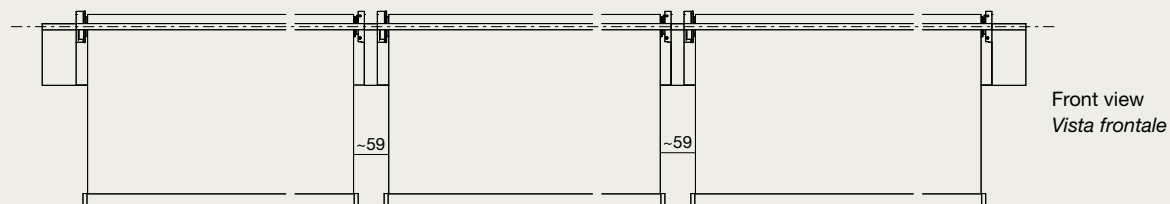

Collection guide

Top

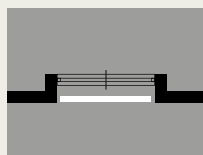

Minimum lateral extent
Minimo ingombro laterale



Minimum gap between fabrics
Minima distanza tra teli abbinati

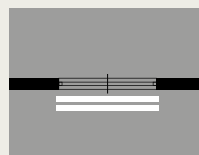

Double system (filtering/blackout)
Doppi (filtrante/oscurante)

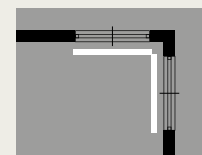

Corner fittings
Installazione ad angolo

Phantom / Standard



Phantom / Maxi



Phantom / Double Vertical



Phantom / Double Horizontal



Phantom / One on One Vertical



Phantom / One on One Horizontal



Simply / Top



Ekstro



Trej / Assym



Groove



Groove / Double



Flexy / Top



Quaver / Top



Quaver / Top Maxi



Quaver / Top Mini



Border / Top



(1) Custom product
Prodotto custom

(2) Solution with overlapping fabrics
Soluzione con teli sovrapposti

(3) L-shaped hook on wall
Aggancio laterale a muro a forma di L

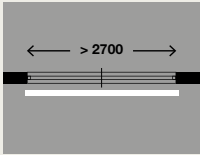

Width larger than 2700 mm
Larghezza superiore a 2700 mm

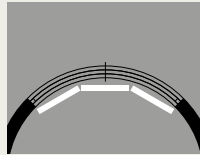

Curving walls
Pareti curve

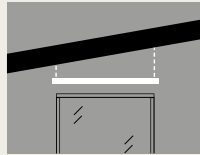

Ceiling beams or roof
Soffitto inclinato o travi a vista



Recessed, floor-to-ceiling window
Ad incasso, vetrata a tutta altezza

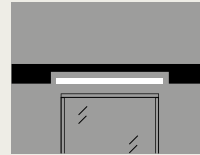

Reduced false ceiling
Controsoffitti di piccole dimensioni

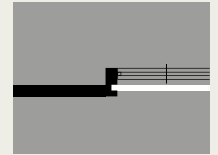

Fully darkening solution with side rails
Guide laterali per oscuramento completo

Width larger than 2700 mm	Curving walls	Ceiling beams or roof	Recessed, floor-to-ceiling window	Reduced false ceiling	Fully darkening solution with side rails
			●	●	● (1)
●			●		● (1)
			●		● (1)
			●		
			●		
			●		
		●			
			●	●	
			●	●	
	●	●			
●					

(4) Version with small lateral support
Variante con supporto laterale ridotto

Collection guide

Wall

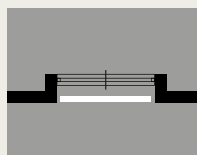

Minimum lateral extent
Minimo ingombro laterale



Minimum gap between cloths
Minima distanza tra teli abbinati

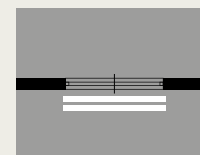

Double system (filtering/blackout)
Doppi (filtrante/oscurante)

Simply / Wall

●

Simply / Line

●

Trej / Wall

●

●

●

Trej / Wall Extended

●

●

Trej / Wall Extended Double

●

●

●

Trej / Wall Side

●

Trej / Wall Side Double

●

●

Flexy / Wall

●

Quaver / Wall

●

●

●

Quaver / Wall Maxi

●

●

●

Quaver / Wall Mini

●

Border / Wall

● (2)

●

(1) With side cables
Con cavetti laterali

(2) Version with small lateral support
Variante con supporto laterale ridotto

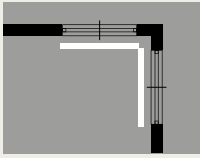

Corner fittings
Installazione ad angolo

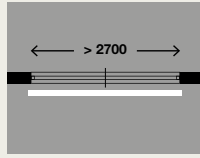

Width larger than 2700 mm
Larghezza superiore a 2700 mm

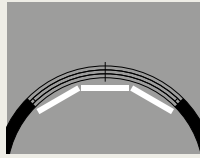

Curving walls
Pareti curve

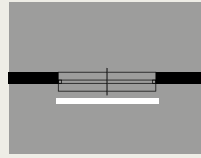

Bulky handle
Modelli sporgenti

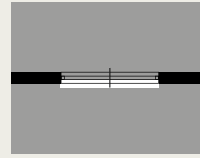

Mounted on window frame
Installazione su serramento

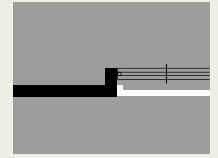

Mounted on side wall
Installazione su parete laterale

•

•

•

•

•

•

•

•

•

•

•

•

•

•

• (1)

Download link

Scan the QR code on the right to download additional materials and technical information of Mycore products.

Scansiona il QR code sulla destra per scaricare materiali aggiuntivi e informazioni tecniche sui prodotti Mycore.



Finishes guide



Phantom / Standard	<input type="radio"/>			
Phantom / Maxi	<input type="radio"/>			
Phantom / Double Vertical	<input type="radio"/>			
Phantom / Double Horizontal	<input type="radio"/>			
Phantom / One on One Vertical	<input type="radio"/>			
Phantom / One on One Horizontal	<input type="radio"/>			
Simply / Top	<input checked="" type="radio"/>		<input type="radio"/>	
Simply / Wall	<input checked="" type="radio"/>		<input type="radio"/>	
Simply / Line	<input checked="" type="radio"/>		<input type="radio"/>	
Ekstro	<input checked="" type="radio"/>	<input checked="" type="radio"/>	<input type="radio"/>	
Trej / Assym	<input checked="" type="radio"/>	<input checked="" type="radio"/>	<input type="radio"/>	
Trej / Wall	<input checked="" type="radio"/>	<input checked="" type="radio"/>	<input type="radio"/>	<input checked="" type="radio"/>
Trej / Wall Extended			<input type="radio"/>	
Trej / Wall Extended Double			<input type="radio"/>	
Trej / Wall Side			<input type="radio"/>	
Trej / Wall Side Double			<input type="radio"/>	

Finish proposed as default
Finitura proposta come opzione predefinita

More info on our website → mycore.it

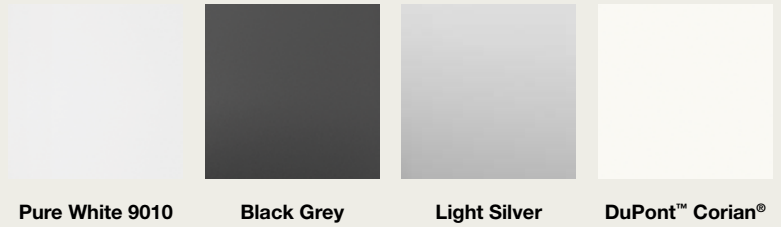

Groove	○		● (1)	
Groove / Double	○		● (1)	
Flexy / Top	● (2)		○	
Flexy / Wall	● (2)		○	
Quaver / Top	●	●	○	●
Quaver / Wall	●	●	○	●
Quaver / Top Maxi	●	●	○	●
Quaver / Wall Maxi	●	●	○	●
Quaver / Top Mini	●		○	
Quaver / Wall Mini	●		○	
Border / Top	●		○	
Border / Wall	●		○	

(1) Internal surface of the frame in black colour
Superficie interna del telaio in colore nero

(2) Includes surfaces in Light Silver finish
Include delle superfici con finitura Light Silver

Mycore Collections Catalogue

Art direction,
concept, layout:
Arianna Balloch
Gruppo Pragma

Images:
Nudesign

Print:
Litostil

Mycore® is a registered trademark.
All designs are registered.
All information, drawings and
images are property of Mycore®
and can not be used without
prior written authorization.

*Mycore® è un marchio registrato.
Tutti i modelli sono registrati.
Tutti i dati, disegni ed immagini
sono di proprietà di Mycore®
e l'autorizzazione all'utilizzo deve
essere concessa in forma scritta.*

Printed on paper from well-managed forests
in accordance with natural resources.
*Stampato su carta proveniente da foreste
gestite nel rispetto delle risorse naturali.*



G.S. Srl
S.S. Pontebbana
Km 146,10 — n. 54/B
33017 Collalto — Tarcento
Udine — Italia
T. +39 0432 782052
mycore.it



mycore.it