



*Outdoor — Open Air*



**CARATTERISTICHE TECNICHE**  
**TECHNICAL DETAILS**

|  |  |
|--|--|
| <b>Tipologia di sistema</b><br><i>Type of system</i>                           | tenda a rullo verticale da esterno con cavi laterali in acciaio inox Ø 4 mm<br><i>outdoor vertical roller system with stainless steel side cables Ø 4 mm</i>       |
| <b>Azionamenti</b><br><i>Operation</i>   | a motore STD / a motore RF radiofrequenza / ad argano<br><i>electric operated through STD or RF motor device / winch operated</i>                                  |
| <b>Automatismi</b><br><i>Automatism</i>  | automatismi per l'azionamento automatico della tenda in base a sole e vento<br><i>sun and wind sensor for the automatic operation of the roller system</i>         |
| <b>Optional</b><br><i>Optional accessories</i>                                 | controllo della tenda tramite smartphone (solo per motore RF)<br><i>system control through smartphone (only for RF motor device)</i>                               |
| <b>Lato comando</b><br><i>Operation side</i>                                   | a sinistra o a destra del sistema (visto dall'esterno)<br><i>on the left or on the right side of the system (view from outside)</i>                                |
| <b>Cassonetto</b><br><i>Cassette</i>   | tondo in alluminio estruso verniciato Ø 120 mm (solo per modello Tube)<br><i>round cassette in painted extruded aluminium Ø 120 mm (only for the Tube version)</i> |
| <b>Tubo di avvolgimento</b><br><i>Roller tube</i>                              | in acciaio zincato Ø 78 mm<br><i>made of galvanized steel, Ø 78 mm</i>   |
| <b>Contrappeso</b><br><i>Counterweight</i>                                     | tondo Ø 40 mm, nascosto all'interno della tasca sul tessuto<br><i>round counterweight Ø 40 mm, hidden inside recess on the fabric</i>                              |
| <b>Supporti e viterie</b><br><i>Brackets and screws</i>                        | in acciaio inox<br><i>made of stainless steel</i>  |
| <b>Tessuti</b><br><i>Fabrics</i>   | tessuti schermanti, tessuti oscuranti, tessuti stampabili<br><i>screen fabrics, black-out fabrics, printable fabrics</i>   |
| <b>Installazione</b><br><i>Installation</i>                                    | a parete, a soffitto o in nicchia<br><i>wall-mounted, ceiling-mounted or recessed</i>  |
| <b>Fissaggio inferiore dei cavi</b><br><i>Anchoring cables lower fastening</i> | raso pavimento, basetta a pavimento, basetta a parete<br><i>close to the ground or through a metallic plate fastened to the ground or to the wall</i>              |
| <b>Discesa del telo</b><br><i>Lowering of the fabric</i>                       | dietro (standard) o davanti all'avvolgibile, vista dall'esterno<br><i>behind (standard) or in front of the roller, view from outside</i>                           |
| <b>Resistenza al vento</b><br><i>Wind resistance</i>                           | classe 1, secondo la normativa europea UNI EN 13561<br><i>class 1, according to UNI EN 13561 European regulation</i>   |
| <b>Certificazioni</b><br><i>Certifications</i>                                 | tutti i prodotti sono marcati CE<br><i>all products are CE marking</i>   |

# Open Air, sistema a rullo outdoor

Con la sua estetica contemporanea e le sue performance elevate di protezione solare, Open Air è una tenda da esterno in perfetto stile Mycore. Dotata di cavetti laterali che guidano la discesa della tenda in verticale, permette di schermare e proteggere gli ambienti interni.

## Open Air, outdoor roller system

*With its contemporary design and high sun protection performances, Open Air is the outdoor roller system expressing Mycore style. It is provided with side cables to drive the vertical fabric lowering, allowing to screen and protect furnishings and interior environment.*



## Finiture

Verniciatura da outdoor con polveri epossidiche a base di resina di poliesteri.

### Finishes

*Outdoor painting with epoxy and polyester resin-based powder.*

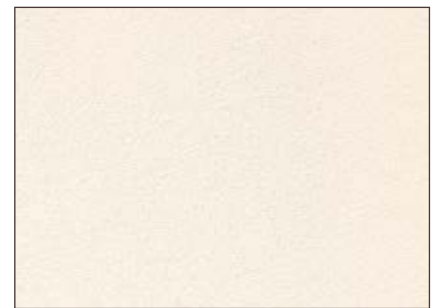

**BIANCO**  
**WHITE**



**GRIGIO**  
**GREY**



**ANTRACITE**  
**ANTHRACITE**

## OPEN AIR – TUBE

A parete  
On wall mounted

VISTA FRONTALE / FRONT VIEW

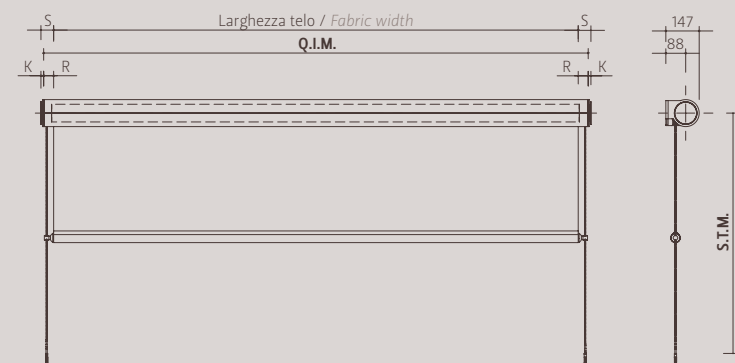

VISTA DALL'ALTO / UPPER VIEW

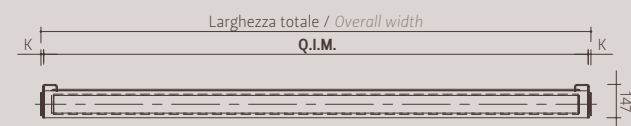

COMBINAZIONE MULTIPLA / MULTIPLE COMBINATION

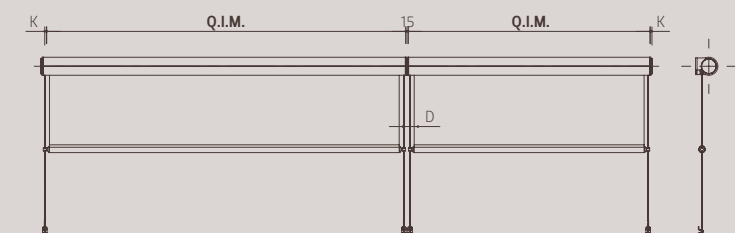

Dimensioni caratteristiche  
per ciascun tipo di azionamento  
Typical dimensions for each  
type of operation

| Motore / Motor |       |
|----------------|-------|
| K 12           | D 100 |
| R 40           | S 52  |

A soffitto  
On ceiling mounted

VISTA FRONTALE / FRONT VIEW

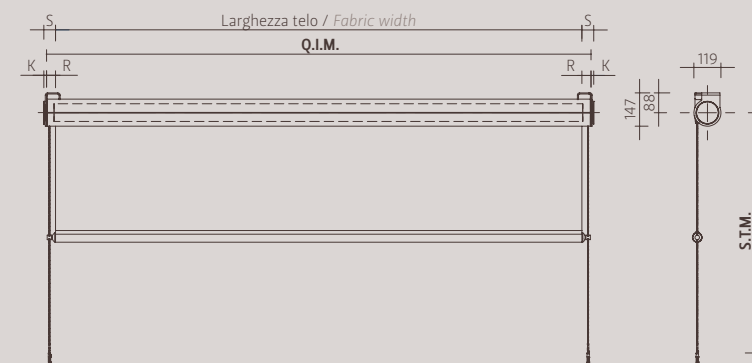

VISTA DALL'ALTO / UPPER VIEW

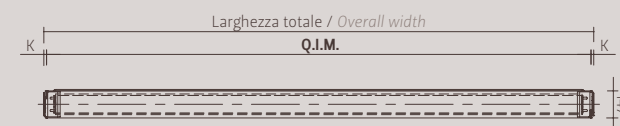

COMBINAZIONE MULTIPLA / MULTIPLE COMBINATION

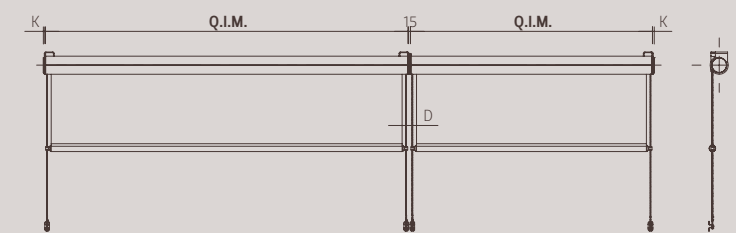

Dimensioni caratteristiche  
per ciascun tipo di azionamento  
Typical dimensions for each  
type of operation

| Motore / Motor |       |
|----------------|-------|
| K 12           | D 100 |
| R 40           | S 52  |

## Fissaggio inferiore dei cavi / Anchoring cables lower fastening

VISTE LATERALI / SIDE VIEWS

### RASO PAVIMENTO

Ancoraggio a filo pavimento  
con tassello  
**FLUSH-FLOOR FIXING**  
Flush-floor installation  
using dowel pin

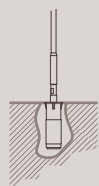

### BASETTA A PAVIMENTO

Ancoraggio a pavimento  
con basetta metallica  
**FLOOR FIXING**  
On floor installation  
through a metallic plate

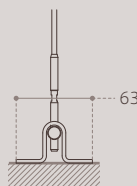

### BASETTA A PARETE

Ancoraggio a parete  
con basetta metallica  
**WALL FIXING**  
On wall installation  
through a metallic plate

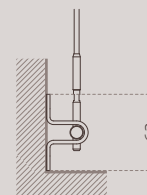



# Tessuti

Ampia collezione di tessuti sia schermanti che oscuranti, in grado di soddisfare ogni esigenza estetica e di protezione dall'irraggiamento solare e dai raggi UV; ampia gamma di colori disponibili in linea con le nuove tendenze dell'architettura.

## Fabrics

*Wide textile collection that includes both screen and black-out fabrics. It permits to satisfy every aesthetic and technical need through the protection from sunshine and UV rays; wide selection of available colours in step with the last architectural trends.*



MADE IN ITALY

INOX

ALU



## OPEN AIR – FREE

### A parete On wall mounted

VISTA FRONTALE / FRONT VIEW

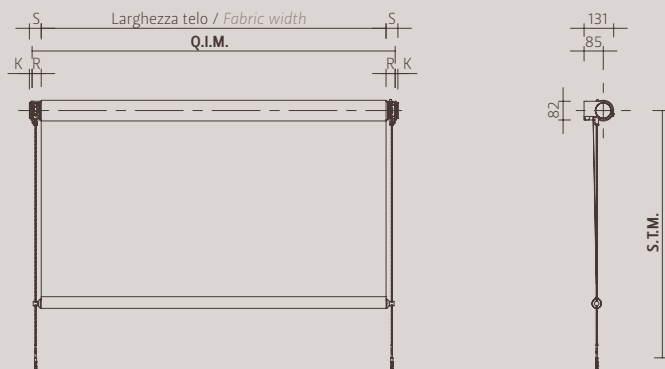

VISTA DALL'ALTO / UPPER VIEW

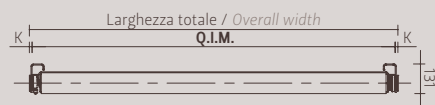

COMBINAZIONE MULTIPLA / MULTIPLE COMBINATION

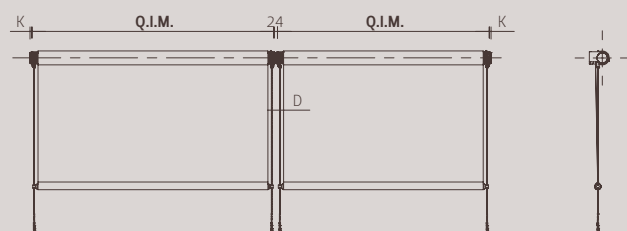

Dimensioni caratteristiche  
per ciascun tipo di azionamento  
Typical dimensions for each  
type of operation

| Motore / Motor |       |
|----------------|-------|
| K 12           | D 105 |
| R 40           | S 52  |

### A soffitto On ceiling mounted

VISTA FRONTALE / FRONT VIEW

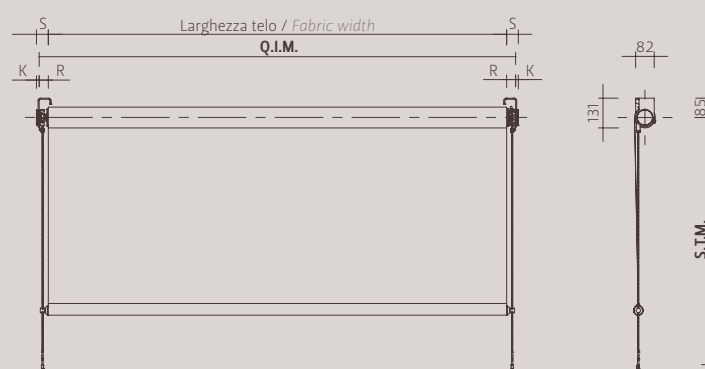

VISTA DALL'ALTO / UPPER VIEW

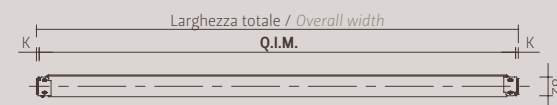

COMBINAZIONE MULTIPLA / MULTIPLE COMBINATION

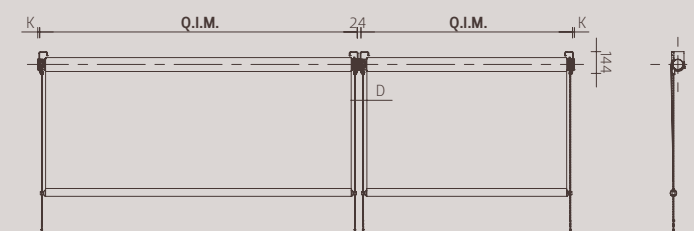

Dimensioni caratteristiche  
per ciascun tipo di azionamento  
Typical dimensions for each  
type of operation

| Motore / Motor |       |
|----------------|-------|
| K 12           | D 105 |
| R 40           | S 52  |

## Fissaggio inferiore dei cavi / Anchoring cables lower fastening

VISTE LATERALI / SIDE VIEWS

### RASO PAVIMENTO

Ancoraggio a filo pavimento  
con tassello

#### FLUSH-FLOOR FIXING

Flush-floor installation  
using dowel pin

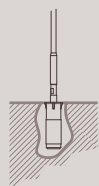

### BASETTA A PAVIMENTO

Ancoraggio a pavimento  
con basetta metallica

#### FLOOR FIXING

On floor installation  
through a metallic plate

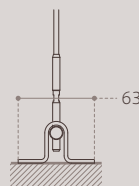

### BASETTA A PARETE

Ancoraggio a parete  
con basetta metallica

#### WALL FIXING

On wall installation  
through a metallic plate

